



ACCU'S KLEIN MATERIAAL EN UNIVERSEEL

EPS AUTOMOTIVE | PASSIE | SPECIALIST | FOCUS

KM2025-03

Inhoudsopgave

Aanhangwagen toebehoren	25
Accu's	3
Accu's Motorfiets	7
Accu's Semi Tractie	9
Accu benodigdheden	10
Batterijen	52
Bougiekabel op rol	60
Brandstofpomp universeel	60
Brandstofslang	50
Caramba technische spray's	19
Carterpluggen+ringen	60
Electrodraad	47
Eurol additieven + overige	56
Gegolfde pijp	45
Krimpkous	46
Krimptangen	29
Knijp/Krimp verbinders	30
Kabelbinders	44
Lampen	51
Lamphouder	52
Lagers, Kogellagers Timken	54
Persoonlijke beschermingsmiddelen	21
Remleiding + nippels	23
Remschijf montage bout	55
Ruitensproeierslang	48
Slangklemmen	49
Steekbehuizingset	29
Stekkers + stekkerdozen	26
Tape	45
Terugslagklep	60
Truck slangen en kabels	28
Uitlaatdelen, universeel	13
Werklampen	53
Werklampen Philips	61
Zekeringen	37

MIDAC accu's

Artikelnummer	Korte codes	Ah	A (-18°C)	Afmetingen in MM			Layout	Polen	Model	Aantal	Aantal
		20h	EN 7,5V 10"	L	B	H		TYPE		Pallet	Laag
ITINERIS AGM - STOP & START - ABSORPTIVE GLASS MAT											
S560.901.068	IT2 AGM	60	680	242	175	190	0	1	B3	76	19
S570.901.076	IT3 AGM	70	760	275	175	190	0	1	B3	64	16
S580.901.080	IT4 AGM	80	800	310	175	190	0	1	B3	56	14
S595.901.085	IT5 AGM	95	850	353	175	190	0	1	B3	48	12
S605.901.095	IT6 AGM	105	950	393	175	190	0	1	B3	48	12
ITINERIS EFB - STOP & START - CYCLING FLOODED BATTERIES											
S555.501.050	IT1 EFB	50	500	207	175	190	0	1	B3	96	24
S560.501.057	IT2 EFB	60	570	242	175	190	0	1	B3	76	19
S565.501.065	IT3B EFB	65	650	275	175	175	0	1	B3	64	16
S572.501.072	IT3 EFB	72	720	275	175	190	0	1	B3	64	16
S575.501.073	IT4B EFB	75	730	310	175	175	0	1	B3	56	14
S580.501.077	IT4 EFB	80	770	310	175	190	0	1	B3	56	14
S600.501.085	IT5 EFB	100	850	353	175	190	0	1	B3	48	12
ITINERIS EFB - STOP & START - Japanese Types - CYCLING FLOODED BATTERIES											
S537.601.037	IT37J EFB	37	370	195	127	225	0	3	B0	128	32
S555.601.046	IT55J EFB	55	460	237	127	225	0	3	B0	96	24
S565.601.056	IT65J EFB	65	560	230	170	225	0	1	B0	80	20
S572.601.066	IT72J EFB	72	660	270	175	225	0	1	B0	72	18
S595.601.076	IT95J EFB	95	760	303	175	225	0	1	B0	60	15
SIGILLUM - STANDARD DIN											
S555.059.052	S1	55	520	207	175	190	0	1	B3	96	24
S564.059.063	S2	64	630	242	175	190	0	1	B3	76	19
S582.031.077	S3	82	770	275	175	190	0	1	B3	64	16
S600.035.082	S4	100	820	310	175	190	0	1	B3	56	14
S600.038.086	S5	100	860	353	175	190	0	1	B3	48	12
SIGILLUM - LOW DIN											
S550.065.050	S1B	50	500	207	175	175	0	1	B3	96	24
S563.077.061	S2B	63	610	242	175	175	0	1	B3	76	19
S574.018.072	S3B	74	720	275	175	175	0	1	B3	64	16
S584.039.078	S4B	84	780	310	175	175	0	1	B3	56	14
S592.038.080	S5B	92	800	353	175	175	0	1	B3	48	12
HERMETICUM - STANDARD DIN											
S530.040.033	H30	30	330	195	130	183	0	4	B0		
S530.041.033	H30S	30	330	195	130	183	1	4	B0		
S544.008.042	H44	44	420	175	175	190	0	1	B3	96	24
S550.059.045	H50	50	450	207	175	190	0	1	B3	96	24
S555.060.050	H55	55	500	207	175	190	0	1	B3	96	24
S555.064.050	H55S	55	500	207	175	190	1	1	B3	96	24

MIDAC accu's

Artikelnummer	Korte codes	Ah	A (-18°C)	Afmetingen in MM			Layout	Polen	Model	Aantal	Aantal
		20h	EN 7,5V 10"	L	B	H		TYPE		Pallet	Laag
HERMETICUM - STANDARD DIN											
S562.059.059	H62	62	590	242	175	190	0	1	B3	76	19
S562.065.059	H62S	62	590	242	175	190	1	1	B3	76	19
S574.012.068	H74	74	680	275	175	190	0	1	B3	64	16
S574.013.068	H74S	74	680	275	175	190	1	1	B3	64	16
S580.031.072	H80	80	720	275	175	190	0	1	B3	64	16
S600.035.080	H100	100	800	310	175	190	0	1	B3	56	14
S600.065.080	H100S	100	800	310	175	190	1	1	B3	56	14
S600.038.083	HL100	100	830	353	175	190	0	1	B3	48	12
HERMETICUM - LOW DIN											
S547.065.045	H47B	47	450	207	175	175	0	1	B3	96	24
S562.077.059	H62B	62	590	242	175	175	0	1	B3	76	19
S572.018.068	H72B	72	680	275	175	175	0	1	B3	64	16
S582.039.074	H82B	82	740	310	175	175	0	1	B3	56	14
S592.015.080	H92B	92	800	353	175	175	0	1	B3	48	12
HERMETICUM - STANDARD JIS											
S537.020.033	H37J	37	330	187	127	225	0	3	B0	100	25
S537.022.033	H37JS	37	330	187	127	225	1	3	B0	100	25
S537.038.033	H37J1	37	330	187	135	225	0	3	B1	100	25
S545.077.030	H45E	45	300	218	135	225	0	1	B1	100	25
S545.079.030	H45ES	45	300	218	135	225	1	1	B1	100	25
S545.084.036	H45J	45	360	237	127	225	0	3	B0	100	25
S545.051.036	H45JS	45	360	237	127	225	1	3	B0	100	25
S550.041.042	H50J	50	420	200	170	225	0	1	B0	96	24
S550.042.042	H50JS	50	420	200	170	225	1	1	B0	96	24
S560.068.049	H60J	60	460	230	170	225	0	1	B0	76	19
S560.069.049	H60JS	60	460	230	170	225	1	1	B0	76	19
S570.029.056	H70J	70	560	270	175	225	0	1	B3 (+B6)	48	16
S570.024.056	H70JS	70	560	270	175	225	1	1	B3 (+B6)	48	16
S595.018.076	H95J	95	760	303	175	225	0	1	B6	56	14
S595.019.076	H95JS	95	760	303	175	225	1	1	B6	56	14
CELERIS - STANDARD DIN											
540.008.036	C40	40	360	175	175	190	0	1	B3	96	24
544.059.040	C44	44	400	207	175	190	0	1	B3	96	24
550.059.045	C50	50	450	207	175	190	0	1	B3	96	24
560.059.054	C60	60	540	242	175	190	0	1	B3	76	19
570.038.064	C70	70	640	275	175	190	0	1	B3	64	16
574.012.068	C74	74	680	275	175	190	0	1	B3	64	16

MIDAC accu's

Artikelnummer	Korte codes	Ah	A (-18°C)	Afmetingen in MM			Layout	Polen	Model	Aantal	Aantal
		20h	EN 7,5V 10"	L	B	H		TYPE		Pallet	Laag
CELERIS - STANDARD DIN											
588.027.074	CL88	88	740	353	175	190	0	1	B3	48	12
600.035.079	C100	100	790	310	175	190	0	1	B3	56	14
600.038.081	CL100	100	810	353	175	190	0	1	B3	48	12
610.042.095	C110	110	950	393	175	190	0	1	B3		
CELERIS - LOW DIN											
544.065.040	C44B	44	400	207	175	175	0	1	B3	96	24
560.077.052	C60B	60	520	242	175	175	0	1	B3	76	19
570.018.064	C70B	70	640	275	175	175	0	1	B3	64	16
580.039.070	C80B	80	700	310	175	175	0	1	B3	56	14
HERCULES - SHD (SUPER HEAVY DUTY)											
S650.105.085	SHD150	150	850	510	189	223	3	1	B0	32	8
S680.108.105	SHD180	180	1050	513	223	223	3	1	B0	28	7
S730.103.125	SHD230	230	1250	518	273	240	3	1	B0	18	6
FORTIS - HD (HEAVY DUTY)											
S635.034.085	135AS	135	850	510	189	223	3	1	B0	32	8
S650.020.090	150AS	150	900	510	189	223	3	1	B0	32	8
S650.089.090	150B	150	900	513	223	223	4	1	B3	28	7
S650.017.090	150BS	150	900	513	223	223	3	1	B0	28	7
S680.089.100	180B	180	1000	513	223	223	4	1	B3	28	7
S680.032.100	180BS	180	1000	513	223	223	3	1	B0	28	7
S700.029.110	200B	200	1100	513	223	223	4	1	B3	28	7
S700.088.110	200BS	200	1100	513	223	223	3	1	B0	28	7
S725.016.120	225C	225	1200	518	273	240	4	1	B0	18	6
S725.018.120	225CS	225	1200	518	273	240	3	1	B0	18	6
FORTIS											
S600.032.080	100G	100	800	330	175	205	0	1	B3	56	14
S600.033.080	100GS	100	800	330	175	205	1	1	B3	56	14
S610.029.074	110B1	110	740	343	175	230	0	1	B1	36	12
S610.028.074	110B0	110	740	343	175	230	0	1	B0	36	12
S610.027.074	110BS	110	740	343	175	230	1	1	B0	36	12
S610.040.085	110MDS	110	850	513	175	210	3	1	B3	32	8
S620.033.082	120M	120	820	510	175	225	4	1	B3	32	8
S625.026.076	125AT	125	760	343	175	290	4	1	B0	36	12
S635.044.090	135MS	135	900	513	175	210	3	1	B3	32	8
S640.011.090	140MT	140	900	510	175	205	4	1	B1	32	8
S650.044.100	150MS	150	1000	510	175	225	3	1	B3	32	8

MIDAC accu's

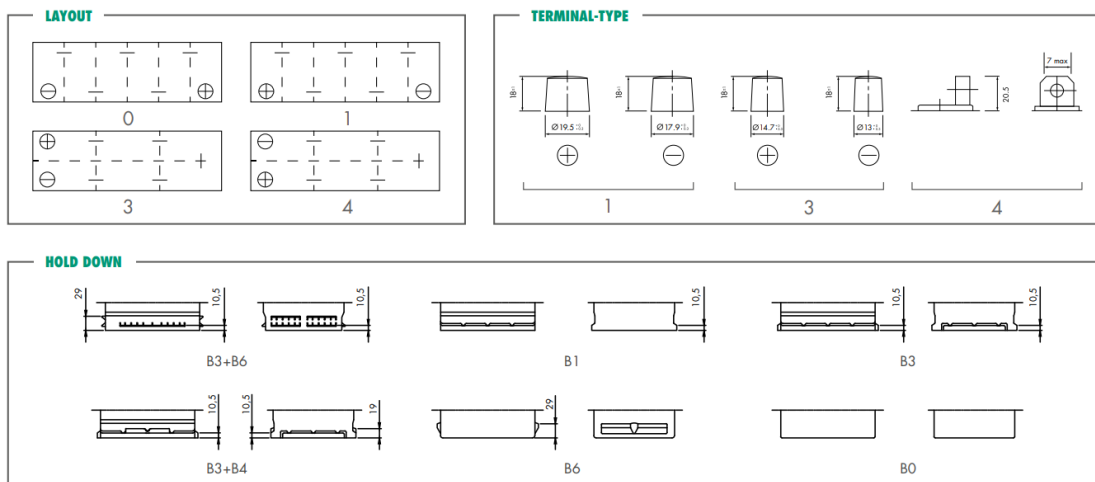

Model	Beschrijving
	ITINERIS AGM AGM staat voor Absorbed Glass Mat. Bij een AGM accu is het accuzuur opgenomen in gewezen glasvezelmatten die zich tussen de loodplaten van de accu bevinden. AGM accu's hebben een lange levensduur, geringe zelfontlading en zijn onderhoudsvrij.
	ITINERIS EFB EFB staat voor "Enhanced Flooded Battery". Er is een weefsel toegevoegd op de positieve plaat. Door dit weefsel wordt de laad- en ontladprestatie vele malen beter/snelser dan een normale standaard startaccu. Hierdoor is de EFB accu zeer geschikt voor de start/stop systemen in de auto. Doordat de toevoeging in de accu is gedaan is het koud start vermogen (CCA) ook hoger.
	SIGILLUM - STANDARD DIN / LOW DIN Maximaal startvermogen (+30% in inschakelstroom) om prestaties te garanderen bij voertuigen die een hoog energieverbruik vereisen, zelfs in extreme omstandigheden. Uitgerust met dubbel deksel en geïntegreerd labyrintsysteem voor maximale veiligheid.
	HERMETICUM - STANDARD DIN / LOW DIN / JIS Betrouwbaarheid en hoge prestaties voor maximaal vermogen op traditionele motoren zonder Stop&Start-systeem. Uitgerust met dubbel deksel en geïntegreerd labyrintsysteem voor maximale veiligheid. Een compleet assortiment voor Europese en ook Aziatische productieauto's.
	CELERIS - STANDARD DIN / LOW DIN Deze onderhoudsvrije accu biedt de juiste prijs/kwaliteitsverhouding. Volledige productie in Italië. De accu's worden in de fabriek pas geladen als onze orders door worden gegeven. Daarom is iedere accu die ons magazijn bereikt maximaal 1 week oud.
	HERCULES - SHD (SUPER HEAVY DUTY) Superieure prestaties voor super uitgeruste voertuigen. Zeer lage auto-uitstoot en geen onderhoud. Geproduceerd met glaswolafscheider, verstoppingsysteem en hars op elke cel, voor superieure trillingsbestendigheid. Maximaal veiligheidsniveau dankzij de nieuwe afdekking met intern labyrint en dubbele "vlamdover".
	FORTIS / FORTIS HD (HEAVY DUTY) Ideaal voor de meeste toepassingen en biedt betrouwbaarheid en kracht op lange termijn. Geen onderhoud door gebruik van Ca/Ca technologie. Ook verkrijgbaar in de HD-versie met glaswolafscheider voor verhoogde weerstand tegen trillingen en om de levensduur te verlengen.

MIDAC motorfiets accu's



Artikelnr	DIN	Ah	EN	lxbxh	Polen	gasafvoer	Type pool
STANDARD 12 V - Classic range droog geladen met zuurpakket							
MB3L-B	50311	3	32	99x57x111	+	•	A
MB4L-B	50411	4	50	120x70x92	+	•	A
MB5L-B	50512	5	55	120x60x130	+	•	A
MB7-A	50713	8	90	135x75x133	+	•	A
MB7L-B	50712	8	90	135x75x133	+	•	A
MB9-B	50914	9	130	135x75x139	+	•	A
MB9L-B	50915	9	80	137x76x140	+	•	A
MB10L-A2	51112	11	160	135x90x145	+	•	F
MB10L-B	51113	11	160	135x90x145	+	•	A
MB10L-B2	51114	11	160	135x90x145	+	•	F
MB12A-A	51211	12	165	134x80x160	+	•	A
MB12A-B	51215	12	165	134x80x160	+	•	A
MB12AL-A2	51213	12	165	135x81x162	+	•	F
MB14-A2	51412	14	190	134x89x166	+	•	F
MB14-B2	51414	14	190	134x89x166	+	•	F
MB14L-A2	51411	14	190	134x89x166	+	•	F
MB14L-B2	51413	14	190	134x89x166	+	•	F
MB16AL-A2	51616	16	190	205x70x162	+	•	B
MB16B-A	51615	16	190	160x90x160	+	•	D
M50-N18L-A	52012	20	260	205x90x162	+	•	E
M60-N30L-A	53030	30	300	187x130x170	+	•	C
M60-N30-A	53034	30	300	187x130x170	+	•	C
MB49-6	00811	10	50	91x83x161	+		A
6N11A-1B	01214	11	80	122x62x132	+	•	A
STANDARD 12 V - Classic range droog geladen met zuurpakket							
MB16-B	51912	19	240	175x100x155	+	•	A
M12N20AH	51814	20	250	186x82x171	+	•	C
CB9L-B	50915	9	80	137x76x140			
AGM 12 V - Premium gesloten AGM met zuurpakket							
MTX4L-BS	50314	4	50	113x70x86	+		D
MTX5L-BS	50412	5	70	113x70x105	+		D
MTZ7S-BS	50702	6	95	113x70x105	+		D
MT7B-BS	50701	6	90	150x65x93	+		D
MTX7L-BS	50614	6	85	113x70x130	+		D
MTX7A-BS	50615	7	90	150x87x93	+		D
MT9A-BS	50904	9	130	135x76x138	+		D
MT9B-BS	50902	8	120	150x69x105	+		D



MIDAC motorfiets accu's

AGM 12 V - Premium gesloten AGM met zuurpakket							
MTZ10S-BS	51015	8,6	130	150x87x93	+		D
MTX9-BS	50812	8	110	150x87x105	+		D
MTZ12S-BS	50901	11	160	150x87x110	+		D
MT12A-BS	51101	10	120	150x87x105	+		D
AGM 12 V - Premium gesloten AGM met zuurpakket							
MT12B-BS	51201	10	120	150x69x130	+		D
MTX12-BS	51012	10	160	150x87x130	+		D
MTX12A-BS	51013	10	210	150x87x106		+	C
MTZ14S-BS	51401	11,2	150	150x87x110	+		D
MTX14-BS	51214	12	190	150x87x145	+		D
MTX14AHL-BS	51215	12	200	134x89x166		+	F
MTX16-BS	51601	14	210	150x87x161	+		D
MTX20CH-BS	51803	18	270	150x87x161	+		D
MTX20L-BS	51801	18	270	175x87x155		+	D
MTX20HL-BS	51802	18	310	175x87x155		+	D
MIX30L-BS	53000	30	390	166x126x177	+		D
MTX20-BS	82001	18	270	175x87x155		+	D
GEL - 12V Premium Plus Gel							
GEL 12-4L-B	50411	5	70	120x71x91		+	D
GEL 12-4L-BS	50314	4	60	114x71x86		+	D
GEL 12-5L-BS	50412	5	80	113x69x105		+	D
GEL 12-7L-BS	50614	7	120	113x69x130		+	D
GEL 12-7A-BS	50615	7	120	151x87x94	+		D
GEL 12-7Z-S	50702	6	120	114x71x106		+	D
GEL 12N9-4B-1	50914	10	170	135x75x139	+		A
GEL 12N9-4B-4	50798	8	170	150x65x92	+		D
GEL 12-9-BS	50812	9	170	151x87x105	+		D
GEL 12-10B-4	50801	9	180	151x87x94	+		D
GEL 12-12AL-A	51213	12	210	134x80x161		+	A
GEL 12-12B-4	51201	10	210	150x69x130	+		D
GEL 12-12-BS	51012	12	210	151x87x130	+		D
GEL 12-14B-4	51203	12	250	150x69x145	+		D
GEL 12-14-BS	81214	14	250	150x87x145	+		D
GEL 12-14L-A2	51411	14	250	134x88x166		+	D
GEL 12-14ZS	51102	11	250	151x87x110	+		D
GEL 12-16 BS	81216	16	250	180x75x165		+	D
GEL 12-N50-18L-A	52012	20	300	205x87x162		+	D
GEL 12-19 BMW + ABS	52113	21	300	183x79x171		+	C
GEL C60-N30L-A	53030	30	420	178x123x166		+	C
GEL 12-19-BS	82213	22	300	185x75x170		+	C
GEL C60-N30-A	53034	30	400	178x123x166	+		C

MIDAC motorfiets accu's

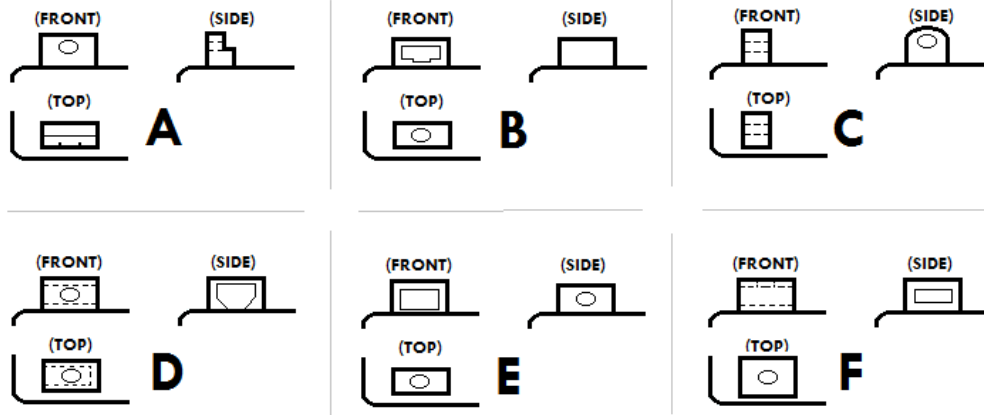
Polen schema Motorfiets accu's



SEMI TRACTIE				
	Artikelnummer	Ah	LxBxH	
	ST95602SMF	80	278x175x190	Plus rechts
	ST95752SMF	100	353x175x190	Plus rechts
	ST31DCSMF	105	330x172x235	Plus links dubbele pool

Accu benodigdheden



Insteekbehuizingsset

Artikelnummer:	mm ²	Stroom	VPE:
50390580	6mm ² - 13mm ²	50A	1 st.
50390581	25mm ² - 35mm ²	175A	1 st.
50390582	50mm ² - 70mm ²	350A	1 st.

Handgreep Voor 50390580



Artikelnummer:	VPE:
50390680	1 st.

Handgreep Voor 50390581/82



Artikelnummer:	VPE:
50390681	1 st.

Startkabelsets

Basic:



16mm²

Artikelnummer:		VPE:
52289948	Basic	1 set
52289749	Premium	1 set

Premium:



25mm²

Artikelnummer:		VPE:
52289950	Basic	1 set
52289764	Premium	1 set

NIEUW

35mm²

Artikelnummer:		VPE:
52289853	Basic	1 set
52289782	Premium	1 set

50mm²

Artikelnummer:		VPE:
52289885	Basic	1 set
52289237	Premium	1 set

NIEUW

Massastrips

Massastrips zonder Klem

Afmeting`	Lengte	Artikelnummer	VPE:
16mm ² - 19mm breed	200mm	52287834	1 st.
	250mm	52287836	1 st.
	300mm	52287838	1 st.
	350mm	52287839	1 st.
	400mm	52287840	1 st.
21,2mm ² -21mm breed	150mm	52287807	1 st.
	200mm	52287810	1 st.
	250mm	52287812	1 st.
	300mm	52287814	1 st.
	350mm	52287815	1 st.
	400mm	52287816	1 st.
	500mm	52287817	1 st.
	600mm	52287820	1 st.



Massastrips met Klem

Afmeting`	Lengte	Artikelnummer	VPE:
21,2mm ² -21mm breed	200mm	52287020	1 st.
	250mm	52287025	1 st.
	300mm	52287030	1 st.
	350mm	52287035	1 st.
	400mm	52287040	1 st.
	500mm	52287050	1 st.
	600mm	52287060	1 st.



Accupoolklemmen

Accupoolklemset (+/-)
Quick Power

Artikelnummer:	VPE:
52285210003	Blisterverpakking 1 st.

Accupoolklem + (plus)
Renault/Peugeot

Artikelnummer:	VPE:
52285191	1 st.

Accupoolklem Afsluiter
Quick Breaker

Artikelnummer:	VPE:
52285240066	Blisterverpakking 1 st.

Accupoolklem - (min)
Renault/Peugeot

Artikelnummer:	VPE:
52285192	1 st.

Accupoolklem
Quick Lock

Artikelnummer:	+ / -	Diam. Accupool	VPE:
52285220	+ (plus)	17,6mm	5 st.
52285221	- (min)	15,9mm	5 st.



Accupoolklem
Dunne Pool

Artikelnummer:	+ / -	Diam. Accupool	VPE:
52285160	+ (plus)	12,8mm	5 st.
52285161	- (min)	11,2mm	5 st.



Accupoolklem
+ (plus) 17,5mm / - (min) 15,9mm

Artikelnummer:	+ / -	VPE:
52285040	+ (plus)	25 st.
52285041	- (min)	25 st.
52285040066	(+/-) in Blister	1 set



Accupoolklem Massief
+ (plus) 17,5mm / - (min) 15,9mm

Artikelnummer:	+ / -	VPE:
52285140	+ (plus)	10 st.
52285141	- (min)	10 st.



Accupoolklem Recht
+ (plus) 17,5mm / - (min) 15,9mm

Artikelnummer:	+ / -	VPE:
52285070	+ (plus)	10 st.
52285071	- (min)	10 st.

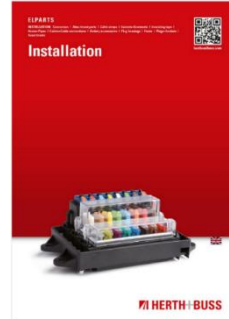

**Zie "Herth&Buss
Elparts Installation"
documentatie voor alle
overige artikelen.**

Accupoolklemmen Truck

+ (plus) 17,5mm / - (min) 15,9mm

Artikelnummer:	+ / -	VPE:
52285080	+ (plus)	5 st.
52285081	- (min)	5 st.



Artikelnummer:	+ / -	VPE:
52285090	+ (plus)	5 st.
52285091	- (min)	5 st.



Universele uitlaatdelen

Pijpklemmen M8

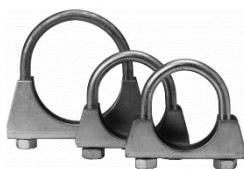

Artikelnummer:	Maat:	VPE:
911-932	32mm	1 st.
911-936	36mm	1 st.
911-938	38mm	1 st.
911-940	40mm	1 st.
911-942	42mm	1 st.
911-945	45mm	1 st.
911-948	48mm	1 st.
911-950	50mm	1 st.
911-952	52mm	1 st.
911-954	54mm	1 st.
911-958	58mm	1 st.
911-960	60mm	1 st.
911-965	65mm	1 st.
911-967	67mm	1 st.
911-970	70mm	1 st.
911-976	76mm	1 st.

Pijpklemmen M10

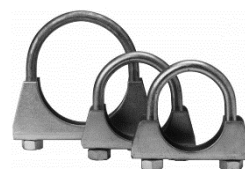

Artikelnummer:	Maat:	VPE:
913-945	45mm	1 st.
913-954	54mm	1 st.
913-960	60mm	1 st.
913-990	90mm	1 st.
913-915	115mm	1 st.
913-925	125mm	1 st.

Pijpklemmen VAG



Artikelnummer:	Maat:	VPE:
951-945	45,5mm	1 st.
951-946	46,7mm	1 st.
951-948	48,5mm	1 st.
951-949	49,5mm	1 st.
951-954	54,5mm	1 st.
951-960	60,5mm	1 st.
951-964	64,5mm	1 st.

Pijpverbinder/Spangklem

Citroën C1
Peugeot 107
Toyota Aygo

Artikelnr. Maat
774-954 54mm

VPE: 1 st.



Uitlaatklemmen Citroën/Peugeot



Artikelnummer:	Maat:	VPE:
931-947	47mm	1 st.
931-953	53mm	1 st.
931-958	58mm	1 st.
931-966	66mm	1 st.
931-969	69mm	1 st.

Uitlaatklemmen Renault



Artikelnummer:	Maat:	VPE:
932-947	47mm	1 st.
932-949	49mm	1 st.
932-953	53mm	1 st.
932-958	58mm	1 st.
932-961	61mm	1 st.
932-966	66mm	1 st.
932-969	69mm	1 st.
932-972	72mm	1 st.
932-979	79mm	1 st.

Universele uitlaatdelen



Pijpverbinders

Artikelnummer:	Maat:	VPE:
004-938	38x95mm	1 st.
114-943	43x125mm	1 st.
004-945	45x125mm	1 st.
114-946	46x90mm	1 st.
004-948	48x90mm	1 st.
114-952	50x90mm	1 st.
114-950	50x125mm	1 st.
004-954	55x90mm	1 st.
114-956	56x125mm	1 st.
114-960	60x95mm	1 st.
114-961	60x125mm	1 st.



Beugel, Uitlaatsysteem

Artikelnummer:	Maat:	VPE:
239-901	Citroën	1 st.
124-903	Opel	1 st.
219-904	Peugeot	1 st.
239-905	Citroën / Peugeot	1 st.
554-906	Volvo	1 st.
109-921	Mini	1 st.
109-923	Mini	1 st.
223-927	Renault	1 st.
99.1349-AS	Renault	1 st.
223-939	Renault	1 st.
239-903	Citroën / Peugeot	1 st.
239-904	Citroën / Peugeot	1 st.
219-903	Citroën / Peugeot	1 st.



Uitlaatpijp gebogen 2 meter

Artikelnummer:	Maat:	VPE:
99.1500-AS	40mm	1 st.
99.1501-AS	45mm	1 st.
99-1502-AS	50mm	1 st.
99.1503-AS	55mm	1 st.
99.1504-AS	60mm	1 st.

Maat pijp is uitwendig



Moer met flens (koper)

Artikelnr:	Maat	VPE:
988-0602.10	M6x1.0 SW10	10
988-0702.10	M7x1.0 SW11	10
988-0804.10	M8x1.25 SW12	10
988-1091.10	M10x1.25 SW14	10
988-1006.10	M10x1.5 SW15	10
988-1205.10	M12x1.5 SW17	10
988-1401.10	M14x1.5 SW19	10

NIEUW



Wist u dat:

Wij naast onze universele uitlaatdelen, ruim 1.800 referenties Uitlaatdelen, Katalysatoren en ophangrubbers op voorraad hebben.

Universele uitlaatdelen



Flexibele uitlaatdelen met pijp

Interlock

Artikelnummer:	Maat:	VPE:
VW440-220	40x220mm	1 st.
VW440-274	40x274mm	1 st.
VW442-220	42x220mm	1 st.
VW445-220	45x220mm	1 st.
VW445-269	45x270mm	1 st.
VW445-274	45x274mm	1 st.
VW445-291	45x290mm	1 st.
VW445-320	45x320mm	1 st.
VW445-360	45x360mm	1 st.
VW448-270	48x270mm	1 st.
VW450-220	50x220mm	1 st.
VW450-271	50x270mm	1 st.
VW450-320	50x320mm	1 st.
VW450-340	50x340mm	1 st.
VW450-360	50x360mm	1 st.
VW455-220	55x220mm	1 st.
VW456-320	55x320mm	1 st.
VW455-330	55x330mm	1 st.
VW455-340	55x340mm	1 st.
VW455-365	55x365mm	1 st.
VW460-220	60x220mm	1 st.
VW460-300	60x300mm	1 st.
VW460-320	60x320mm	1 st.
VW645-290	45x290mm	1 st.
VW650-290	50x290mm	1 st.
VW660-310	60x310mm	1 st.

Flexibele uitlaatdelen met pijp

Inner braid

Artikelnummer:	Maat:	VPE:
438-282	38x282mm	1 st.
440-274	40x274mm	1 st.
442-247	42x247mm	1 st.
442-290	42x290mm	1 st.
442-340	42x340mm	1 st.
445-271	45x272mm	1 st.
445-272	45x272mm	1 st.
445-274	45x274mm	1 st.
445-291	45x290mm	1 st.
445-340	45x340mm	1 st.
448-160	48x160mm	1 st.
448-280	48x280mm	1 st.
448-400	48x400mm	1 st.
450-270	50x270mm	1 st.
450-280	50x280mm	1 st.
450-281	50x280mm	1 st.
450-340	50x340mm	1 st.
452-240	52x240mm	1 st.
452-290	52x290mm	1 st.
452-340	52x340mm	1 st.
455-280	55x280mm	1 st.
455-285	55x285mm	1 st.
455-330	55x330mm	1 st.
455-340	55x340mm	1 st.
457-282	57x282mm	1 st.
460-250	60x250mm	1 st.
460-300	60x300mm	1 st.

Flexibele uitlaatdelen met pijp

Meerdere diameters (IB-Inner Braid / IL – Inner lock)

Artikelnummer:	Maat:	VPE:
450-401	50x400 – 2x100-45/48/51	(IB) 1 st.
450-402	50x400 – 2x150-45/48/51	(IB) 1 st.
455-100	55x400 – 2x150-45/48/55	(IB) 1 st.
455-200	55x400 – 2x100-45/48/55	(IB) 1 st.
458-400	58x400 – 2x147.5-51/53/58	(IB) 1 st.
463-400	63x400 – 2x140-53/58/63	(IB) 1 st.
473-400	73x400 – 2x125-58/63/73	(IB) 1 st.
479-400	79x400 – 2x125-63/73/79	(IB) 1 st.
VW650-240	50x240 – 2x45-45/48/51	(IL) 1 st.
VW455-200	55x400 – 2x100-45/48/55	(IL) 1 st.
VW459-400	59x400 – 2x150-49/52/59	(IL) 1 st.
VW459-401	59x400 – 2x100-49/52/59	(IL) 1 st.



Universele uitlaatdelen



Flexibele uitlaatdelen zonder pijp

Artikelnummer:	Maat:	VPE:
340-100	40x100mm	1 st.
340-160	40x160mm	1 st.
340-200	40x200mm	1 st.
343-200	43x200mm	1 st.
345-100	45x100mm	1 st.
345-120	45x120mm	1 st.
345-150	45x150mm	1 st.
345-190	45x190mm	1 st.
345-200	45x200mm	1 st.
345-230	45x230mm	1 st.
345-260	45x260mm	1 st.
345-280	45x280mm	1 st.
348-100	48x100mm	1 st.
348-200	48x200mm	1 st.
348-230	48x230mm	1 st.
350-100	50x100mm	1 st.
350-120	50x120mm	1 st.
350-150	50x150mm	1 st.
350-200	50x200mm	1 st.
350-230	50x230mm	1 st.
350-250	50x250mm	1 st.
350-280	50x280mm	1 st.
350-320	50x320mm	1 st.
352-200	52x200mm	1 st.
352-250	52x250mm	1 st.
355-100	55x100mm	1 st.
355-150	55x150mm	1 st.
355-200	55x200mm	1 st.
355-230	55x230mm	1 st.
355-250	55x250mm	1 st.
355-280	55x280mm	1 st.
357-100	57x100mm	1 st.
357-200	57x200mm	1 st.
357-250	57x250mm	1 st.
360-100	60x100mm	1 st.
360-115	60x115mm	1 st.
360-150	60x150mm	1 st.
360-200	60x200mm	1 st.
360-230	60x230mm	1 st.
360-250	60x250mm	1 st.
360-280	60x280mm	1 st.

Artikelnummer:	Maat:	VPE:
364-120	64x120mm	1 st.
364-150	64x150mm	1 st.
364-200	64x200mm	1 st.
364-250	64x250mm	1 st.
370-150	70x150mm	1 st.
370-200	70x200mm	1 st.
375-110	75x110mm	1 st.
375-200	75x200mm	1 st.
375-250	75x250mm	1 st.

Artikelnummer:	Maat:	VPE:
VW340-100	40x100mm	1 st.
VW345-094	45x94mm	1 st.
VW345-100	45x100mm	1 st.
VW345-190	45x190mm	1 st.
VW345-200	45x200mm	1 st.
VW345-230	45x230mm	1 st.
VW350-100	50x100mm	1 st.
VW350-120	50x120mm	1 st.
VW350-150	50x150mm	1 st.
VW350-190	50x190mm	1 st.
VW350-200	50x200mm	1 st.
VW350-230	50x230mm	1 st.
VW354-075	54x75mm	1 st.
VW355-100	55x100mm	1 st.
VW355-105	55x105mm	1 st.
VW355-120	55x120mm	1 st.
VW355-150	55x150mm	1 st.
VW355-170	55x170mm	1 st.
VW355-200	55x200mm	1 st.
VW360-100	60x100mm	1 st.
VW360-115	60x115mm	1 st.
VW360-150	60x150mm	1 st.
VW360-190	60x190mm	1 st.
VW360-200	60x200mm	1 st.
VW364-100	64x100mm	1 st.
VW364-117	64x117mm	1 st.
VW370-070	70x70mm	1 st.
VW375-150	75x150mm	1 st.

Universele uitlaatdelen



Rechte uitlaatpijp 2m

Artikelnummer:	Maat:	VPE:
99.0320-AS	35mm	1 st.
99.0321-AS	38mm	1 st.
99.0322-AS	40mm	1 st.
99.0323-AS	42mm	1 st.
99.0325-AS	45mm	1 st.
99.0326-AS	48mm	1 st.
99.0327-AS	50mm	1 st.
99.0328-AS	54mm	1 st.
99.0329-AS	60mm	1 st.
599.0775-AS	65mm	1 st.
599.0776-AS	70mm	1 st.
599.0840-AS	76mm	1 st.
599.0777-AS	80mm	1 st.
599.0778-AS	89mm	1 st.
599.0779-AS	102mm	1 st.
599.0780-AS	110mm	1 st.
599.0781-AS	114mm	1 st.
599.0782-AS	120mm	1 st.

Maat pijp is inwendig

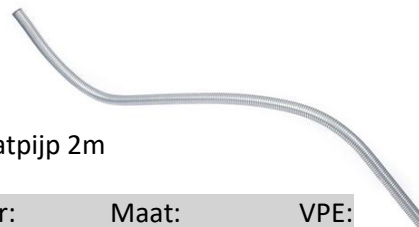

Flexibele uitlaatpijp 2m

Artikelnummer:	Maat:	VPE:
FX30Z2-AS	30mm	1 st.
FX35Z2-AS	35mm	1 st.
FX38Z2-AS	38mm	1 st.
FX40Z2-AS	40mm	1 st.
FX45Z2-AS	45mm	1 st.
FX50Z2-AS	50mm	1 st.
FX55Z2-AS	55mm	1 st.
FX60Z2-AS	60mm	1 st.
FX65Z2-AS	65mm	1 st.
FX70Z2-AS	70mm	1 st.
FX75Z2-AS	75mm	1 st.
FX80Z2-AS	80mm	1 st.
FX85Z2-AS	85mm	1 st.
FX90Z2-AS	90mm	1 st.
FX95Z2-AS	95mm	1 st.
FX101Z2-AS	101mm	1 st.
FX110Z2-AS	110mm	1 st.
FX115Z2-AS	115mm	1 st.
FX120Z2-AS	120mm	1 st.
FX125Z2-AS	125mm	1 st.
FX150Z2-AS	150mm	1 st.

Maat pijp is inwendig

Lasbocht 90 °



Artikelnummer:	Maat:	VPE:
99.0214-AS	40mm	1 st.
99.0215-AS	45mm	1 st.
99.0216-AS	50mm	1 st.
99.0217-AS	60mm	1 st.
599.0916-AS	65mm	1 st.
599.0917-AS	70mm	1 st.
599.0918-AS	80mm	1 st.
599.0919-AS	89mm	1 st.
599.0920-AS	102mm	1 st.
599.0921-AS	110mm	1 st.
599.0922-AS	114mm	1 st.
599.0923-AS	120mm	1 st.

Lasbocht 45 °



Artikelnummer:	Maat:	VPE:
99.0210-AS	40mm	1 st.
99.0211-AS	45mm	1 st.
99.0212-AS	50mm	1 st.
99.0213-AS	60mm	1 st.
599.0924-AS	65mm	1 st.
599.0925-AS	70mm	1 st.
599.0926-AS	80mm	1 st.
599.0927-AS	89mm	1 st.
599.0928-AS	102mm	1 st.
599.0929-AS	110mm	1 st.
599.0930-AS	114mm	1 st.
599.0931-AS	120mm	1 st.

Universele uitlaatdelen

NIEUW

Reparatieset Citroen – Peugeot - Renault

Artikelnummer:	Ø1/ Ø2 x Ø3 x L:	VPE:
006-937	37/40 x 56.0 x 65.5 mm	1 st.
006-941	41/45 x 62.6 x 65.0 mm	1 st.
006-944	44/48 x 66.5 x 65.5 mm	1 st.
006-946	46/50 x 66.5 x 65.5 mm	1 st.
006-950	50/54 x 71.0 x 66.0 mm	1 st.
006-956	56/60 x 80.0 x 64.0 mm	1 st.
006-961	61/65 x 80.0 x 64.0 mm	1 st.

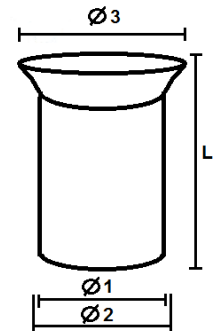

Reparatieset Citroen – Peugeot - Renault

Artikelnummer:	Ø1/ Ø2 x Ø3 x L:	VPE:
006-938	37/40 x 56.3 x 58.3 mm	1 st.
006-942	41/45 x 60.7 x 58.2 mm	1 st.
006-945	44/48 x 67.0 x 59.0 mm	1 st.
006-947	46/50 x 67.0 x 59.0 mm	1 st.
006-951	50/54 x 70.0 x 59.0 mm	1 st.
006-957	56/60 x 77.0 x 59.0 mm	1 st.
006-962	61/65 x 82.0 x 59.0 mm	1 st.

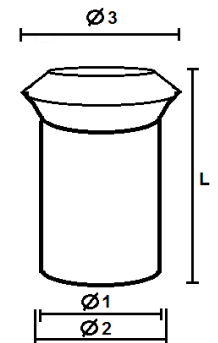

Verloopstuk

Artikelnummer:	ID / ED / L	VPE:
99.0310-AS	32 / 35 / 300 mm	1 st.
99.0312-AS	37 / 40 / 300 mm	1 st.
99.0313-AS	39 / 42 / 300 mm	1 st.
99.0314-AS	40 / 43 / 300 mm	1 st.
99.0315-AS	42 / 45 / 300 mm	1 st.
99.0316-AS	45 / 48 / 300 mm	1 st.
99.0318-AS	53 / 55 / 300 mm	1 st.
99.0319-AS	57 / 60 / 300 mm	1 st.

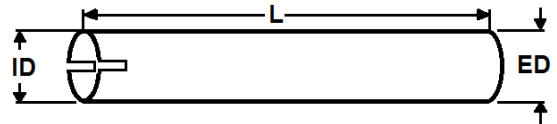

Caramba

Remmenreiniger (Acetonvrij)
500ml



Artikelnummer: 6026381 VPE: 6 st.

Hoogwaardig smeervet met PTFE
500ml



TOPPER

Artikelnummer: 64181601 VPE: 6 st.

Super Plus
500ml



Artikelnummer: 6612011 VPE: 6 st.

Industriereiniger
500ml



Artikelnummer: 60250001 VPE: 6 st.

Roestverwijderaar Rasant
500ml



Artikelnummer: 6007081 VPE: 6 st.

PTFE Spray
500ml



Artikelnummer: 60278505 VPE: 6 st.

Kettingspray
500ml



Artikelnummer: 60628501 VPE: 6 st.

Keramische Pasta
200ml



Artikelnummer: 6905061 VPE: 6 st.

Zink spray licht
500ml



Artikelnummer: 60768505 VPE: 6 st.

Glasschuimreiniger
500ml



Artikelnummer: 6290305 VPE: 6 st.

Caramba

Injectoren Speciaaloplosser
O.a. bij Mercedes motoren
500ml



Artikelnummer: 6610050 VPE: 6 st.

Caramba 70, Multispray Kruipolie
250ml



Artikelnummer: 6006370661 VPE: 6 st.

Velgenreiniger pH-neutraal
500ml



Artikelnummer: 6270064 VPE: 6 st.

Schuimreiniger
500ml



Artikelnummer: 64010601 VPE: 6 st.

Pompsproeier 1l
Voor Remmenreiniger



Artikelnummer: 69320104 VPE: 1 st.

Pompsproeier 1l
Voor Velgenreiniger



Artikelnummer: 69320204 VPE: 1 st.

Handwaspasta 10ltr



Artikelnummer: 6980510 VPE: 1 st.

Olievlekverwijderaar 1l



Artikelnummer: 606801 VPE: 1 st.

Siliconenspray DUO
500ml



Artikelnummer: 6103251 VPE: 6 st.

Super Plus DUO
500ml



Artikelnummer: 6612021 VPE: 6 st.

Persoonlijke Beschermingsmiddelen



Fluoriserend Jasje



Artikelnummer:	VPE:
HJ-000-01	1 st.

Veiligheidshelm Wit



Artikelnummer:	VPE:
HE-000-01	1 st.

Veiligheidsbril



Artikelnummer:	VPE:
HB-000-01	1 st.

Veiligheidsbril Sky Lite Blauw



Artikelnummer:	VPE:
HB-000-02	1 st.

Werkhandschoenen
PU Gecoat



Artikelnummer:	Maat:	VPE:
HS-000-08	8 (M)	1 paar
HS-000-09	9 (L)	1 paar
HS-000-10	10 (XL)	1 paar
HS-000-11	11 (XXL)	1 paar

Werkhandschoenen
Nylon/Spandex



Artikelnummer:	Maat:	VPE:
HS-004-09	9 (L)	1 paar
HS-004-10	10 (XL)	1 paar

Persoonlijke beschermingsmiddelen

Werkhandschoenen
Latex Zwart GRIPPAZ®



Artikelnummer:	Maat:	VPE:
HS-011-07	7 (M)	50 st.
HS-011-08	8 (M)	50 st.
HS-011-09	9 (L)	50 st.
HS-011-10	10 (XL)	50 st.
HS-011-11	11 (XXL)	50 st.
HS-011-12	12 (XXXL)	50 st.

Werkhandschoenen
Latex Oranje GRIPPAZ®



Artikelnummer:	Maat:	VPE:
HS-010-07	7 (M)	50 st.
HS-010-08	8 (M)	50 st.
HS-010-09	9 (L)	50 st.
HS-010-10	10 (XL)	50 st.
HS-010-11	11 (XXL)	50 st.
HS-010-12	12 (XXXL)	50 st.

Werkhandschoenen
Rundsnerfleder



Artikelnummer:	Maat:	VPE:
HS-001-10	10 (XL)	1 paar
HS-001-11	11 (XXL)	1 paar

Vraag naar onze speciale Grippaz
AKTIE prijzen



Werkhandschoenen
Mec Dex Leather Classic



Artikelnummer:	Maat:	VPE:
HS-003-07	7 (S)	1 paar
HS-003-08	8 (M)	1 paar
HS-003-09	9 (L)	1 paar
HS-003-10	10 (XL)	1 paar
HS-003-11	11 (XXL)	1 paar

Werkhandschoenen
Autoplus



Artikelnummer:	Maat:	VPE:
HS-009-09	9 (L)	1 paar
HS-009-10	10 (XL)	1 paar
HS-009-11	11 (XXL)	1 paar

Werkhandschoenen
Mec Dex Leather Dynamic



Artikelnummer:	Maat:	VPE:
HS-002-09	9 (L)	1 paar

Werkhandschoenen
Super Rundsnerflederen Winter



Artikelnummer:	Maat:	VPE:
HS-005-11	11 (XXL)	1 paar

Werkhandschoenen
Kyorene Micro Foam



Artikelnummer:	Maat:	VPE:
HS-007-10	10 (XL)	1 paar

Sleeve
TAEKI 5 universeel



Artikelnummer:	Maat:	VPE:
HS-008-01	universeel	1 paar

Remleiding + nippels



Remleiding, Koper

Artikelnummer:	Diameter	Lengte	VPE:
NR35005K	3,50mm	5m	1 rol
NR35010K	3,50mm	10m	1 rol
NR47505K	4,75mm	5m	1 rol
NR47525K	4,75mm	25m	1 rol
NR47550K	4,75mm	50m	1 rol
NR50005K	5,00mm	5m	1 rol
NR50025K	5,00mm	25m	1 rol
NR60005K	6,00mm	5m	1 rol
NR60025K	6,00mm	25m	1 rol
NR63525K	6,35mm	25m	1 rol
NR80005K	8,00mm	5m	1 rol
NR80025K	8,00mm	25m	1 rol
NR10025K	10,00mm	25m	1 rol

Remleiding, Cunifer

Artikelnummer:	Diameter	Lengte	VPE:
NR45005C	4,50mm	5m	1 rol
NR47505C	4,75mm	5m	1 rol
NR47510C	4,75mm	10m	1 rol
NR47525C	4,75mm	25m	1 rol
NR60005C	6,00mm	5m	1 rol
NR63505C	6,35mm	5m	1 rol
NR80005C	8,00mm	5m	1 rol
NR80025C	8,00mm	25m	1 rol

Remleiding, Staal met PVF ommanteld

Artikelnummer:	Diameter	Lengte	VPE:
NR47505P	4,75mm	5m	1 rol
NR60005P	6,00mm	5m	1 rol

Remleiding doorverbinders



Artikelnummer:	Maat	VPE:
NR10004	4,75mm	1 st.
NR10004C (Voor Cunifer)	4,75mm	1 st.
NR10006	5,00mm	1 st.
NR10007	6,00mm	1 st.
NR10008	8,00mm	1 st.
NR10009	3,50mm	1 st.

**Documentatie voor
remleidingen en
leidingwartels vindt u
op onze website
www.epsautomotive.nl
onder "Downloads"**

Remleiding + nippels

Leiding wartel



Artikelnummer: NR00104 (M12x1 - \varnothing 5) VPE: 1 st.

Leiding wartel



Artikelnummer: NR00105A (M10x1 - \varnothing 5.1) VPE: 1 st.

Leiding wartel



Artikelnummer: NR00109 (3/8"x24 - \varnothing 5) VPE: 1 st.

Leiding wartel



Artikelnummer: NR00115 (3/8"x24 - \varnothing 5) VPE: 1 st.

T-verbinding



Artikelnummer: NR00127 (M10x1) VPE: 1 st.

Leiding wartel



Artikelnummer: NR00105 (M10x1 - \varnothing 5) VPE: 1 st.

Leiding wartel



Artikelnummer: NR00105D (M10x1 - \varnothing 5.1) VPE: 1 st.

Leiding wartel



Artikelnummer: NR00114 (7/16"x20 - \varnothing 5) VPE: 1 st.

Leiding wartel



Artikelnummer: NR00116 (M10x1 - \varnothing 5) VPE: 1 st.

Verbinding met verloop



Artikelnummer: NR00129 (M10x1/M12x1) VPE: 1 st.

Assortiment Remleidingnippels
2 dozen, 32 referenties

Artikelnummer:	VPE:
NR90001	1 st.
10x NR00102	10x NR00103
10x NR00103X	10x NR00104
10x NR00105	10x NR00105A
10x NR00105D	10x NR00106
8x NR00107	10x NR00108
10x NR00109	10x NR00110
6x NR00110X	10x NR00111
10x NR00112	10x NR00113
10x NR00114	10x NR00115
10x NR00116	10x NR00117
10x NR00118	10x NR00119
8x NR00121	5x NR00123
5x NR00124	1x NR00127
1x NR00128	2x NR00129
2x NR00133	2x NR00134
2x NR00135	2x NR00142
2x NR00143	10x NR10001
10x NR10002	10x NR10004



Remleidingbuiger



Artikelnummer: NR10204 VPE: 1 st.

Remleidingsnijder



Artikelnummer: NR10206 VPE: 1 st.

Remleidingfels apparaat



Artikelnummer: NR10202 VPE: 1 st.

Aanhangwagen toebehoren

Reflector rond (katoog)
met plakfolie (60mm)

Artikelnummer:	Kleur:	VPE:
78623073	oranje	1 st.
78623074	rood	1 st.
78623075	wit	1 st.



Reflector
met plakfolie (94x44mm)

Artikelnummer:	Kleur:	VPE:
78623139	oranje	1 st.
78623135	rood	1 st.
78623136	wit	1 st.



Reflector
met plakfolie (94x44mm) – gat afstand 70mm

Artikelnummer:	Kleur:	VPE:
78623138	oranje	1 st.



Reflector
(94x44mm) – gat afstand 70mm

Artikelnummer:	Kleur:	VPE:
78623038	oranje	1 st.
78623036	rood	1 st.

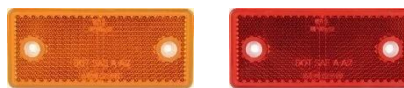

Reflector driehoek
160x140mm – gat afstand 70mm

Artikelnummer:	Kleur:	VPE:
78623110-1	rood	1 st.

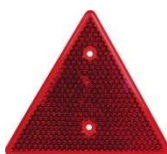

Achtermarkeringsset Truck
565x140mm



Artikelnummer:	Materiaal:	VPE:
78700120	Aluminium	1 set
78700130	Sticker	1 set

Achtermarkeringsset Trailer
565x195mm

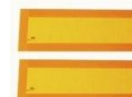

Artikelnummer:	Materiaal:	VPE:
78700171	Aluminium	1 set
78700172	Sticker	1 set

Brekkabel,
Zwart / Rood



Artikelnummer:	Lengte:	VPE:
A000001 (zwart)	1m	1 st.
A000002 (rood)	1m	1 st.
A000003 (zwart)	0,75m	1 st.
A000004 (zwart)	1,25m	1 st.

Lange Lading Bord
500x500 mm – 3mm dik

Artikelnummer:	VPE:
78708501	1 st.



Stekkers + stekkerdozen

Stekker, 7-polig
Aluminium



Artikelnummer:	VPE:
51305520066	1 st.
51305520	25 st.

Stekker, 7-polig
Kunststof



Artikelnummer:	VPE:
51305527066	1 st.
51305527	25 st.

Stekkerdoos, 7-polig
Aluminium



Artikelnummer:	VPE:
51305120066	1 st.
51305120	25 st.

Stekkerdoos, 7-polig
Kunststof



Artikelnummer:	VPE:
51305127066	1 st.
51305127	25 st.

Stekkerdoos, 7-polig
Kunststof
Met uitschakeling mistachterlicht



Artikelnummer:	VPE:
51305140066	1 st.
51305140	25 st.

Stekker, 13-polig
Kunststof



Artikelnummer:	VPE:
51305630	1 st.

Stekkerdoos, 13-polig
Kunststof



Artikelnummer:	VPE:
51305031	1 st.

Stekkerdoos,
7-polig / 13-polig
Kunststof MULTICON



Artikelnummer:	VPE:
51305109	1 st.

Stekker,
7-polig / 13-polig
Kunststof MULTICON



Artikelnummer:	VPE:
51305509	1 st.

Stekkers + stekkerdozen

Stekkerdoos Adapter
Van 13 naar 7-polig



Artikelnummer: 51305470 VPE: 1 st.

Stekkerdoos Adapter
Van 13 naar 7-polig



Artikelnummer: 51305472 VPE: 1 st.

Stekkerdoos Adapter
Van 7 naar 13-polig



Artikelnummer: 51305471 VPE: 1 st.

Stekkerdoos Adapter
Van 7 naar 13-polig



Artikelnummer: 51305474 VPE: 1 st.

Stekker 7-Polig
Aluminium, N-type



Artikelnummer: 51305587 VPE: 1 st.

Stekker 7-Polig
Aluminium, S-type



Artikelnummer: 51305584 VPE: 1 st.

Stekker 7-Polig
Kunststof, N-type



Artikelnummer: 51305589 VPE: 1 st.

Stekker 7-Polig
Kunststof, S-type



Artikelnummer: 51305590 VPE: 1 st.

Stekkerdoos 7-polig
Kunststof, N-type



Artikelnummer: 51305290 VPE: 1 st.

Stekkerdoos 7-polig
Kunststof, S-type



Artikelnummer: 51305291 VPE: 1 st.

Nato stekker



Artikelnummer: 51305916 VPE: 1 st.

Stekkerdoos Nato



Artikelnummer: 51305416 VPE: 1 st.

Truck slangen en kabels

Omschrijving: Artikelnummer: VPE:

Remluchtspiraal, Rood,
M16x1,5 / M22x1,5 4527130010 1 st.



Omschrijving: Artikelnummer: VPE:

Remluchtspiraal, Geel,
M16x1,5 / M22x1,5 4527130020 1 st.



Omschrijving: Artikelnummer: VPE:

Spiraalkabel 15P -> 2x7-polig 51276588 1 st.



Omschrijving: Artikelnummer: VPE:

EBS Kabel 4mtr, 2x4,0 / 5x1,
7-polig 51276656 1 st.



Omschrijving: Artikelnummer: VPE:

Electrospiraal kunststof "N"
7-polig, aangevulcaniseerd 51276670 1 st.



Omschrijving: Artikelnummer: VPE:

Electrospiraal kunststof "S"
7-polig, aangevulcaniseerd 51276671 1 st.



Omschrijving: Artikelnummer: VPE:

Laadstroomkabel 3-polig
6mm met stekkers 51276793-3,5M 1 st.



Omschrijving: Artikelnummer: VPE:

Spiraalkabel
15-polig / 15-polig kunststof 51276671 1 st.



Steekbehuizingsets

Deutsch DT Steekbehuizingset



Artikelnummer:	Aantal polen	VPE:
50390595	2	1 set
50390596	3	1 set
50390597	4	1 set
50390498	6	1 set
50390598	8	1 set
50390599	12	1 set

Deutsch DT Steekbehuizingset



Artikelnummer:	Aantal polen	VPE:
50390600	2	1 set
50390601	3	1 set
50390602	4	1 set
50390603	6	1 set
50390604	8	1 set
50390605	12	1 set

Superseal Steekbehuizingsets



Artikelnummer:	Aantal polen	VPE:
50390825	1	1 set
50390826	2	1 set
50390827	3	1 set
50390828	4	1 set
50390829	5	1 set
50390830	6	1 set

Krimptang 0,5-6,0 mm²

Artikelnummer:	Maat:	VPE:
90942260	-	1 st.



Krimptang Crimpro 30 - 0,1-25 mm²

Artikelnummer:	Maat:	VPE:
95942166	-	1 st.



Knijp/krimp verbinders

Knijp verbinder Vlak

DIN46245 PVC – Tin gecoat



Breedte:	Draad mm ² :	Hoogte:	Kleur:	Artikelnummer:	VPE:
2,8	0,5-1,0	0,5	Rood	50252500066	25 st.
		0,5	Rood	50252500	100 st.
		0,8	Rood	50252501	100 st.
4,8	0,5-1,0	0,5	Rood	50252505066	25 st.
		0,5	Rood	50252505	100 st.
		0,8	Rood	50252506	100 st.
4,8	1,5-2,5	0,5	Blauw	50252507	100 st.
		0,8	Blauw	50252508	100 st.
6,3	0,5-1,0	0,8	Rood	50252510066	10 st.
		0,8	Rood	50252510	100 st.
		0,8	Rood	50252510099	1250 st.
6,3	1,5-2,5	0,8	Blauw	50252511066	10 st.
		0,8	Blauw	50252511	100 st.
		0,8	Blauw	50252511099	1250 st.
6,3	4,0-6,0	0,8	Geel	50252512	100 st.
8,0	0,5-1,0	0,8	Rood	50252515	100 st.
8,0	1,5-2,5	0,8	Blauw	50252513	50 st.
8,0	4,0-6,0	0,8	Geel	50252514	50 st.

Knijp verbinder Vlak

DIN46245 PVC – Tin gecoat



Breedte:	Draad mm ² :	Hoogte:	Kleur:	Artikelnummer:	VPE:
2,8	0,5-1,0	0,8	Rood	50252519	100 st.
6,3	0,5-1,0	0,8	Rood	50252520066	10 st.
		0,8	Rood	50252520	100 st.
6,3	1,5-2,5	0,8	Blauw	50252521066	10 st.
		0,8	Blauw	50252521	100 st.
6,3	4,0-6,0	0,8	Geel	50252522	100 st.

Knijp verbinder Vlak

Nylon - Messing



Breedte:	Draad mm ² :	Hoogte:	Kleur:	Artikelnummer:	VPE:
6,3	0,5-1,0	0,8	Rood	50254215	50 st.
	1,5-2,5	0,8	Blauw	50254216	50 st.
	4,0-6,0	0,8	Geel	50254217	50 st.

Knijp/krimp verbinders

Knijp verbinder Vlak

PVC – Zilver gecoat



Breedte:	Draad mm ² :	Hoogte:	Kleur:	Artikelnummer:	VPE:
6,3	1,5-2,5	0,8	Blauw	50252517	100 st.
	4,0-6,0	0,8	Geel	50252518	100 st.

Knijp verbinder Vlak

DIN46245 - Nylon – Tin gecoat – AMP positive lock



Breedte:	Draad mm ² :	Hoogte:	Kleur:	Artikelnummer:	VPE:
6,3	1,5-2,5	0,8	Blauw	50252523	100 st.

Knijp verbinder Vlak

DIN46245 PVC – Tin gecoat



Breedte:	Draad mm ² :	Hoogte:	Kleur:	Artikelnummer:	VPE:
6,3	0,5-1,0	0,8	Rood	50254210066	10 st.
		0,8	Rood	50254210	100 st.
6,3	1,5-2,5	0,8	Blauw	50254211066	10 st.
		0,8	Blauw	50254211	100 st.

Knijp verbinder Vlak

DIN46245 PVC – Tin gecoat



Breedte:	Draad mm ² :	Hoogte:	Kleur:	Artikelnummer:	VPE:
6,3	0,5-1,0	0,8	Rood	50252550066	10 st.
		0,8	Rood	50252550	100 st.
6,3	1,5-2,5	0,8	Blauw	50252551066	10 st.
		0,8	Blauw	50252551	100 st.

Knijp verbinder Vlak

Volledig geïsoleerd



Breedte:	Draad mm ² :	Kleur:	Artikelnummer:	VPE:
6,3	0,5-1,0	Rood	50252622	25 st.
6,3	1,5-2,5	Blauw	50252623	25 st.
6,3	4,0-6,0	Geel	50252629	25 st.

Knijp/krimp verbinders

Knijp verbinder Vlak
Volledig geïsoleerd



Draad mm ² :	Breedte	Kleur:	Artikelnummer:	VPE:
0,5-1,0	6,3	Rood	50252625	25 st.
1,5-2,5	6,3	Blauw	50252626	25 st.

Krimp verbinder Rond



Draad mm ² :	Diam:	Kleur:	Artikelnummer:	VPE:
1,5-2,5	5	Blauw	50252636	25 st.

Krimp verbinder Rond – Plug



Draad mm ² :	Diam:	Kleur:	Artikelnummer:	VPE:
0,5-1,5	4	Rood	50252631	25 st.
1,5-2,5	5	Blauw	50252635	25 st.

Knijp verbinder Rond
PVC – Tin gecoat



Draad mm ² :	Diam:	Kleur:	Artikelnummer:	VPE:
0,5-1,5	4	Rood	50252530066	10 st.
0,5-1,5	4	Rood	50252530	100st.
1,5-2,5	4	Blauw	50252528	100 st.
1,5-2,5	5	Blauw	50252531066	10 st.
1,5-2,5	5	Blauw	50252531	50 st.
4,0-6,0	5	Geel	50252536	50 st.

Knijp verbinder Rond - Plug
PVC – Tin gecoat



Draad mm ² :	Diam:	Kleur:	Artikelnummer:	VPE:
0,5-1,5	4	Rood	50252532066	10 st.
0,5-1,5	4	Rood	50252532	100 st.
1,5-2,5	4	Blauw	50252529	100 st.
1,5-2,5	5	Blauw	50252533066	10 st.
1,5-2,5	5	Blauw	50252533	100 st.
4,0-6,0	5	Geel	50252537	100 st.

Knijp/krimp verbinders

Knijp doorverbinder

DIN 46245 – PVC – Tin gecoat



Draad mm ² :	diam:	Lengte:	Kleur:	Artikelnummer:	VPE:
0,5-1,0	1,6 / 3,2	15 / 25	Rood	50252540066	10 st.
			Rood	50252540	100 st.
1,5-2,5	2,3 / 4,0	15 / 25	Blauw	50252541066	10 st.
			Blauw	50252541	100 st.
4,0-6,0	3,6 / 5,6	15 / 27	Geel	50252543	50 st.

Krimp doorverbinder



Draad mm ² :		Kleur:	Artikelnummer:	VPE:
0,1-0,5	-	Grijs	50252555066	10 st.
	-	Grijs	50252555	50 st.
	-	Grijs	50252555098	1000 st.
0,5-1,5	-	Rood	50252552066	10 st.
	-	Rood	50252552	50 st.
	-	Rood	50252552099	1000 st.
	Met lijm	Rood	50252562	50 st.
	Met lijm	Rood	50252562099	1000 st.
1,5-2,5	-	Blauw	50252553066	10 st.
	-	Blauw	50252553	50 st.
	-	Blauw	50252553099	1000 st.
	Met lijm	Blauw	50252563	50 st.
	Met lijm	Blauw	50252563099	1000 st.

Krimp doorverbinder



Draad mm ² :		Kleur:	Artikelnummer:	VPE:
3,0-6,0	-	Geel	50252554066	10 st.
	-	Geel	50252554	25 st.
	-	Geel	50252554099	500 st.
	Met lijm	Geel	50252564	25 st.
	Met lijm	Geel	50252564099	500 st.

Knijp/krimp verbinders

Knijpverbinder Oog

DIN46237 - Polyamide - Tin gecoat



Draad mm ² :	Gat mm:	Schroef:	Kleur:	Artikelnummer:	VPE:
0,5-1,0	3,7	M3	Rood	50252118	100 st.
	4,3	M4	Rood	50252112066	10 st.
	4,3	M4	Rood	50252112	100 st.
	5,3	M5	Rood	50252113	100 st.
	6,5	M6	Rood	50252114	100 st.
	8,4	M8	Rood	50252115	100 st.
	10,5	M10	Rood	50252116	50 st.
1,5-2,5	3,7	M3	Blauw	50252126	100 st.
	4,3	M4	Blauw	50252121066	10 st.
	4,3	M4	Blauw	50252121	100 st.
	5,3	M5	Blauw	50252122066	10 st.
	5,3	M5	Blauw	50252122	100 st.
	6,5	M6	Blauw	50252123066	10 st.
	6,5	M6	Blauw	50252123	100 st.

Knijpverbinder Oog

DIN46237 - Polyamide - Tin gecoat



Draad mm ² :	Gat mm:	Schroef:	Kleur:	Artikelnummer:	VPE:
1,5-2,5	8,4	M8	Blauw	50252124066	10 st.
	8,4	M8	Blauw	50252124	100 st.
	10,5	M10	Blauw	50252125	50 st.
4,0-6,0	4,3	M4	Geel	50252159	50 st.
	5,3	M5	Geel	50252160	50 st.
	6,5	M6	Geel	50252161	50 st.
	8,4	M8	Geel	50252162	50 st.
	10,5	M10	Geel	50252163	50 st.

Knijpverbinder Oog

DIN 46234



Draad mm ² :	Gat mm:	Lengte:	Parameter:	Artikelnummer:	VPE:
0,5-1,0	4,3	11	4-1	50251012	100 st.
	5,3	13	5-1	50251013	100 st.
	8,4	17	8-1	50251015	100 st.

Knijp/krimp verbinders

Knijpverbinder Oog
DIN 46234



Draad mm ² :	Gat mm:	Lengte:	Parameter:	Artikelnummer:	VPE:
1,5-2,5	3,2	11	3-2,5	50251020	100 st.
	4,3	12	4-2,5	50251021	100 st.
	5,3	14	5-2,5	50251022	50 st.
	6,5	16	6-2,5	50251023	50 st.
	8,4	17	8-2,5	50251024	50 st.
	10,5	19	10-2,5	50251025	50 st.
4,0-6,0	4,3	14	4-6	50251060	100 st.
	5,3	15	5-6	50251061	100 st.
	6,5	16	6-6	50251062	100 st.
	8,4	19	8-6	50251063	50 st.
	10,5	21	10-6	50251064	50 st.
	13	21	12-6	50251065	50 st.
10,0	5,3	16	5-10	50251100	50 st.
	6,5	17	6-10	50251101	50 st.
	8,4	20	8-10	50251102	50 st.
	10,5	21	10-10	50251103	50 st.
	13	23	12-10	50251104	50 st.
16,0	5,3	20	5-16	50251159	50 st.
	6,5	20	6-16	50251160	50 st.
	8,4	22	8-16	50251161	50 st.
	10,5	24	10-16	50251162	50 st.
	13	31	12-16	50251163	50 st.
25,0	6,5	25	6-25	50251250	25 st.
	8,4	25	8-25	50251251	25 st.
	10,5	26	10-25	50251252	25 st.
	13	31	12-25	50251253	25 st.
35,0	6,5	26	6-35	50251349	25 st.
	8,4	26	8-35	50251350	25 st.
	10,5	27	10-35	50251351	25 st.
	13	31	12-35	50251352	25 st.

Knijp/krimp verbinders

Knijpverbinder Oog DIN 46234



Draad mm ² :	Gat mm:	Lengte:	Parameter:	Artikelnummer:	VPE:
35,0	8,4	34	8-50	50251500	10 st.
	10,5	34	10-50	50251501	10 st.
	13	36	12-50	50251502	10 st.
50,0-70,0	8,4	38	8-70	50251703	10 st.
70,0	10,5	38	10-70	50251700	10 st.
	13	38	12-70	50251701	10 st.
95,0	10,5	42	10-95	50251950	1 st.
	13	42	12-95	50251951	1 st.
120,0	13	44	12-120	50251120	1 st.

Soldeer doorverbinder – met tin



Draad mm ² :	Montage diam:	Lengte:	Kleur:	Artikelnummer:	VPE:
0,1-0,5	1,7	26	Blauw/wit	50252639066	10 st.
			Blauw/wit	50252639	50 st.
0,5-1,0	2,8	38	Rood	50252640066	10 st.
			Rood	50252640	50 st.
1,0-2,0	4,4	38	Blauw	50252641066	10 st.
			Blauw	50252641	50 st.
2,0-3,0	5,8	38	Geel	50252642066	10 st.
			Geel	50252642	50 st.

Soldeer doorverbinder – met tin



Draad mm ² :	Binnen diam:	Lengte:	Kleur:	Artikelnummer:	VPE:
1,0-3,0	2,5 / 3,0	24,5	Blauw	50252643	10 st.
0,5-4,8	4,3 / 4,8	29,3	Blauw	50252644	10 st.
2,8-6,7	6 / 6,7	32,0	Blauw/Grijs	50252645	10 st.
2,8-7,3	6,8 / 7,3	32,5	Blauw	50252646	10 st.
4,0-11,5	10,8 / 11,5	35,5	Blauw	50252648	10 st.
4,0-9,2	8,7 / 9,2	35,5	Wit/Blauw	50252647	10 st.
6,5-15,1	13 / 15,1	45,5	Wit	50252649	10 st.

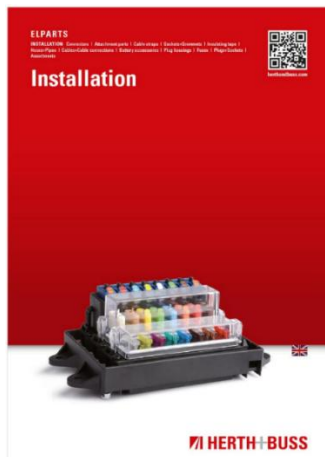

Zie de "Herth&Buss Elparts Installation" documentatie voor alle artikelen. Deze documentatie is te bestellen in onze webshop. Art.nr: KATALOG04EN

Zekeringen

Norm ATO Steekzekeringen

Artikelnummer:	Stroomsterkte:	Kleur:	VPE:
50295401	1 A	Zwart	50 st.
50295402	2 A	Grijs	50 st.
50295403	3 A	Lila	50 st.
50295404	4 A	Roze	50 st.
50295405	5 A	Lichtbruin	50 st.
50295407	7,5 A	Bruin	50 st.
50295410	10 A	Rood	50 st.
50295415	15 A	Lichtblauw	50 st.
50295420	20 A	Geel	50 st.
50295425	25 A	Wit	50 st.
50295430	30 A	Groen	50 st.
50295431	35 A	Groen/Blauw	50 st.
50295440	40 A	Oranje	50 st.



**Klein-verpakkingen voor
steekzekeringen:
"Artikelnummer + 066"**

Norm ATO Steekzekeringen Smart-Glow

Artikelnummer:	Stroomsterkte:	Kleur:	VPE:
50295803066	3 A	Lila	10 st.
50295805066	5 A	Lichtbruin	10 st.
50295807066	7,5 A	Bruin	10 st.
50295810066	10 A	Rood	10 st.
50295815066	15 A	Lichtblauw	10 st.
50295820066	20 A	Geel	10 st.
50295825066	25 A	Wit	10 st.
50295830066	30 A	Groen	10 st.

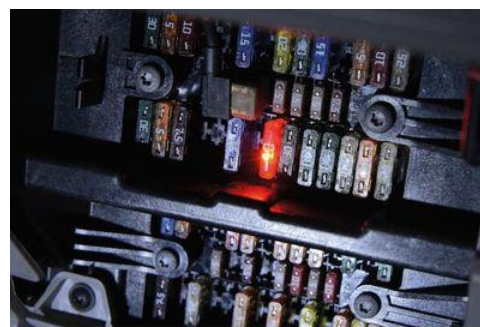

Blister assortiment Norm ATO Steekzekeringen

Artikelnummer:	Stroomsterkte:	VPE:
50296116066	3 A t/m 30 A	10 st.



Blister assortiment Norm ATO Steekzekeringen Smart-Glow

Artikelnummer:	Stroomsterkte:	VPE:
50296800066	5 A t/m 20 A	5 st.

Steekzekeringtrekker Standaard / Mini / Maxi



Artikelnummer:	VPE:
90942401	5 st.

Steekzekeringtrekker Standaard / Mini



Artikelnummer:	VPE:
90942403	1 st.

Zekering tester



Artikelnummer:	VPE:
90945340	1 st.

Zekeringen

MINI Steekzekeringen

Artikelnummer:	Stroomsterkte:	Kleur:	VPE:
50295772	2 A	Grijs	50 st.
50295773	3 A	Lila	50 st.
50295774	4 A	Roze	50 st.
50295775	5 A	Lichtbruin	50 st.
50295776	7,5 A	Bruin	50 st.
50295777	10 A	Rood	50 st.
50295778	15 A	Blauw	50 st.
50295779	20 A	Geel	50 st.
50295780	25 A	Wit	50 st.
50295781	30 A	Groen	50 st.



**Klein-verpakkingen voor
steekzekeringen:
"Artikelnummer + 066"**

MINI Steekzekeringen Smart-Glow

Artikelnummer:	Stroomsterkte:	Kleur:	VPE:
50295673066	3 A	Lila	10 st.
50295675066	5 A	Lichtbruin	10 st.
50295676066	7,5 A	Bruin	10 st.
50295677066	10 A	Rood	10 st.
50295678066	15 A	Lichtblauw	10 st.
50295679066	20 A	Geel	10 st.
50295680066	25 A	Wit	10 st.
50295681066	30 A	Groen	10 st.

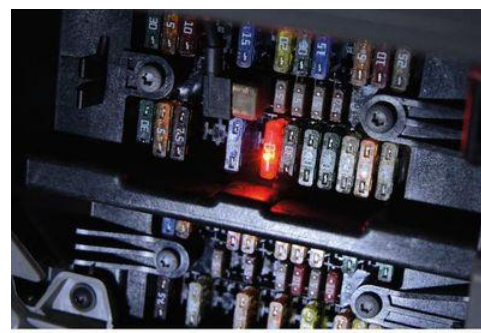

Blister assortiment MINI Steekzekeringen

Artikelnummer:	Stroomsterkte:	VPE:
50296577066	5 A t/m 30 A	10 st.



Blister assortiment MINI Steekzekeringen Smart-Glow

Artikelnummer:	Stroomsterkte:	VPE:
50296670066	5 A t/m 20 A	5 st.

Blister assortiment MICRO2 Steekzekeringen

Artikelnummer:	Stroomsterkte:	VPE:
50296647066	5 A t/m 30 A	7 st.



Blister assortiment MICRO3 Steekzekeringen

Artikelnummer:	Stroomsterkte:	VPE:
50296667066	5 A t/m 15 A	4 st.



Blister assortiment MINI LP Steekzekeringen

Artikelnummer:	Stroomsterkte:	VPE:
50296797066	2 A t/m 30 A	14 st.









Blister assortiment MULTI6 Steekzekeringen

Artikelnummer:	Stroomsterkte:	VPE:
50295162	5 A	1 st.
50295163	7,5 A	1 st.





Zekeringen

Blok Zekeringen

Type Zekering:	Artikelnummer:	Stroomsterkte:	Kleur:	VPE:
 JCase	50295478	20 A	Blauw	1 st.
	50295483	25 A	Wit	1 st.
	50295479	30 A	Roze	1 st.
	50295480	40 A	Groen	1 st.
	50295481	50 A	Rood	1 st.
	50295482	60 A	Geel	1 st.
 Low Profile JCase	50295330	20 A	Blauw	1 st.
	50295331	25 A	Wit	1 st.
	50295332	30 A	Roze	1 st.
	50295333	40 A	Groen	1 st.
	50295334	50 A	Rood	1 st.
	50295335	60 A	Geel	1 st.
 MCase	50295339	15 A	Grijs	1 st.
	50295340	20 A	Blauw	1 st.
	50295341	25 A	Wit	1 st.
	50295342	30 A	Roze	1 st.
	50295343	40 A	Groen	1 st.
 MCase Gekerft	50295353	20 A	Blauw	1 st.
	50295354	25 A	Wit	1 st.
	50295355	30 A	Roze	1 st.
	50295356	40 A	Groen	1 st.
	50295357	50 A	Rood	1 st.
	50295358	60 A	Geel	1 st.
 PAL-AS	50295432	20 A	Blauw	1 st.
	50295433	30 A	Roze	1 st.
	50295434	40 A	Groen	1 st.
	50295435	50 A	Rood	1 st.
	50295436	60 A	Geel	1 st.
	 PAL-B	50295443	30 A	Roze
50295444		40 A	Groen	1 st.
50295445		50 A	Rood	1 st.
50295446		60 A	Geel	1 st.
50295447		70 A	Bruin	1 st.
50295448		80 A	Zwart	1 st.
50295449		100 A	Blauw	1 st.
50295450		120 A	Wit	1 st.
50295451		140 A	Rood	1 st.
 PAL-C		50295453	30 A	Roze
	50295454	40 A	Groen	1 st.
	50295455	50 A	Rood	1 st.
	50295456	60 A	Geel	1 st.
	50295457	70 A	Bruin	1 st.
	50295458	80 A	Zwart	1 st.
	50295459	100 A	Blauw	1 st.
	50295460	120 A	Wit	1 st.

Zekeringen

Blok Zekeringen

Type Zekering:	Artikelnummer:	Stroomsterkte:	Kleur:	VPE:
 PAL-CS	50295462	30 A	Roze	1 st.
	50295463	40 A	Groen	1 st.
	50295464	50 A	Rood	1 st.
	50295465	60 A	Geel	1 st.
	50295466	70 A	Bruin	1 st.
	50295467	80 A	Zwart	1 st.
	50295468	100 A	Blauw	1 st.
	50295469	120 A	Wit	1 st.
	 PAL-D	50295470	25 A	Bruin
50295471		30 A	Groen	1 st.
 PAL-E	50295472	45 A	Rood	1 st.
	50295473	65 A	Zwart	1 st.
	50295474	75 A	Grijs	1 st.

Glaszekeringen 5mm x 20mm



Artikelnummer:	Stroomsterkte:	VPE:
50295041	0,2 A	10 st.
50295044	0,5 A	10 st.
50295048	1 A	10 st.
50295249	1,6 A	10 st.
50295050	2 A	10 st.
50295051	2,5 A	10 st.
50295052	3,15 A	10 st.
50295053	4 A	10 st.
50295005	5 A	10 st.
50295054	6,3 A	10 st.
50295055	8 A	10 st.
50295056	10 A	10 st.

Glaszekeringen 6,3mm x 32mm



Artikelnummer:	Stroomsterkte:	VPE:
50295150	5 A	10 st.
50295151	10 A	10 st.
50295152	15 A	10 st.
50295153	20 A	10 st.
50295154	25 A	10 st.
50295155	30 A	10 st.
50295159	35 A	10 st.

Blister assortiment

Glaszekering 6,3mm x 32mm

Artikelnummer:	Stroomsterkte:	VPE:
50296155066	5 A t/m 30 A	5 st.

Torpedo Zekeringen



Artikelnummer:	Stroomsterkte:	Kleur	VPE:
50295032	5 A	Geel	100 st.
50295034	8 A	Wit	100 st.
50295035	16 A	Rood	100 st.
50295036	25 A	Blauw	100 st.

Blister Assortiment
Torpedozekeringen
incl. glaszekering



Artikelnummer:	Stroomsterkte:	VPE:
50296110066	2 A t/m 25 A	10 st.

Zekeringen

Schroefzekeringen

Type Zekering:	Artikelnummer:	Stroomsterkte:	Kleur:	VPE:
MIDI Zekering	50295858	30 A	Oranje	1 st.
	50295859	40 A	Groen	1 st.
	50295860	50 A	Rood	1 st.
	50295861	60 A	Geel	1 st.
	50295865	70 A	Bruin	1 st.
	50295862	80 A	Wit	1 st.
	50295863	100 A	Blauw	1 st.
	50295864	125 A	Roze	1 st.
	50295866	150 A	Grijs	1 st.
	50295867	200 A	Lila	1 st.
MEGA Zekering	50295876	80 A	Rood	1 st.
	50295870	100 A	Geel	1 st.
	50295871	125 A	Lichtgroen	1 st.
	50295877	150 A	Oranje	1 st.
	50295872	175 A	Wit	1 st.
	50295873	200 A	Blauw	1 st.
	50295878	225 A	Lichtbruin	1 st.
	50295879	250 A	Roze	1 st.
	50295874	300 A	Grijs	1 st.
	50295380	350 A	Groen	1 st.
	50295875	400 A	Lila	1 st.
	50295382	450 A	Beige	1 st.
	50295383	500 A	Bruin	1 st.



Hoofdzekeringen

Type Zekering:	Artikelnummer:	Stroomsterkte:	Kleur:	VPE:
CF Zekering	50295880	50 A	wit	1 st.
	50295881	75 A	wit	1 st.
	50295882	100 A	wit	1 st.
	50295883	125 A	wit	1 st.
	50295884	150 A	wit	1 st.
	50295885	175 A	wit	1 st.
	50295886	200 A	wit	1 st.
	50295887	250 A	wit	1 st.
	50295888	300 A	wit	1 st.



Moer tbv Hoofdzekering

Type Zekering:	Artikelnummer:	Stroomsterkte:	VPE:
	52285550	tot 300 A	1 st.



Zekeringen

Zekeringhouder
Norm ATO Steekzekering



Artikelnummer:	Draad mm ²	VPE:
50290095066	2,5mm ²	1 st.
50290095	2,5mm ²	10 st.

Zekeringhouder
MINI Steekzekering



Artikelnummer:	Draad mm ²	VPE:
50390236066	2,5mm ²	1 st.
50390236	2,5mm ²	10 st.

Zekeringhouder
Glazzekering 5mm x 20mm



Artikelnummer:	Draad mm ²	VPE:
50390257066	1,3mm ²	1 st.
50390257	1,3mm ²	10 st.

Zekeringdoos, 4-polig
Norm ATO Steekzekeringen



Artikelnummer:	VPE:
50300427	1 st.

Zekeringhouder
MEGA Schroefzekeringen



Artikelnummer:	Stroomsterkte	VPE:
50300011	tot 500 A	1 st.

Zekeringhouder
Norm ATO Steekzekering



Artikelnummer:	Stroomsterkte	VPE:
50290093066	2 A t/m 20 A	1 st.
50290093	2 A t/m 20 A	10 st.

Zekeringhouder
Norm ATO Steekzekering



Artikelnummer:	Draad mm ²	VPE:
50390431066	1,3mm ²	1 st.
50390431	1,3mm ²	10 st.

Zekeringhouder
MINI Steekzekering



Artikelnummer:	Draad mm ²	VPE:
50390430066	1,3mm ²	1 st.
50390430	1,3mm ²	10 st.

Zekeringhouder
Torpedo zekering



Artikelnummer:	Diam.	Stroomsterkte	VPE:
50290061066	3mm	8 A	1 st.
50290061	3mm	8 A	10 st.
50290067	3mm	16 A	10 st.

Zekeringdoos, 2-polig
Torpedo Zekeringen



Artikelnummer:	Stroomsterkte	VPE:
50300211066	2 A	1 st.

Zekeringhouder
Zekeringstrips



Artikelnummer:	Stroomsterkte	VPE:
50300067	tot 425 A	1 st.

Zekeringhouder
MAXI Steekzekering



Artikelnummer:	Stroomsterkte	VPE:
50290344	tot 100 A	1 st.

Assortiment
Norm ATO Steekzekeringen
Torpedo Zekeringen



Artikelnummer:	Stroomsterkte	VPE:
54295011	1 A t/m 40 A	354 st.

Assortiment
Norm ATO Steekzekeringen
MINI en MAXI Steekzekeringen



Artikelnummer:	Stroomsterkte	VPE:
54296212	3 A t/m 80 A	478 st.

Assortiment
MICRO2 Steekzekeringen
MICRO3 Steekzekeringen



Artikelnummer:	Stroomsterkte	VPE:
54295640	5 A t/m 30 A	110 st.

Assortiment
Low-Profile MINI Steekzekeringen
Low Profile Blokzekeringen



Artikelnummer:	Stroomsterkte	VPE:
54295040	5 A t/m 60 A	95 st.

Assortiment
MINI Steekzekeringen



Artikelnummer:	Stroomsterkte	VPE:
54295570	1 A t/m 40 A	111 st.

Assortiment
MAXI Steekzekeringen



Artikelnummer:	Stroomsterkte	VPE:
54295540	20 A t/m 100 A	25 st.

Kabelbinder



Kabelbinder Polyamide 6.6

Artikelnummer:	Breedte:	Lengte:	Montage Diam.:	Kleur:	VPE:
50266490	2,5mm	100mm	22mm	Zwart	100 st.
50266491	3,6mm	150mm	35mm	Zwart	100 st.
50266492	4,8mm	200mm	55mm	Zwart	100 st.
50266496	4,8mm	300mm	85mm	Zwart	100 st.
50266493	4,8mm	370mm	110mm	Zwart	100 st.
50266501	7,6mm	370mm	100mm	Zwart	100 st.



Kabelbinder Polyamide 6.6

Artikelnummer:	Breedte:	Lengte:	Montage Diam.:	Kleur:	VPE:
50266004	4,8mm	200mm	55mm	Rood	100 st.
50266003	4,8mm	200mm	55mm	Groen	100 st.
50266002	4,8mm	200mm	55mm	Geel	100 st.
50266001	4,8mm	200mm	55mm	Blauw	100 st.
50266008	4,7mm	390mm	110mm	Rood	100 st.
50266007	4,7mm	390mm	110mm	Groen	100 st.
50266006	4,7mm	390mm	110mm	Geel	100 st.
50266005	4,7mm	390mm	110mm	Blauw	100 st.



Assortiment Kabelbinders Polyamide 6.6

Artikelnummer:	Aantal:
50266070	700 st.

Inhoud	Lengte:	Montage diam:	Kleur:	Artikelnummer:	VPE:
	100	22	Zwart	50266490	100 st.
	150	35	Zwart	50266491	100 st.
	200	55	Blauw	50266001	100 st.
	200	55	Geel	50266002	100 st.
	200	55	Groen	50266003	100 st.
	200	55	Rood	50266004	100 st.
	200	55	Zwart	50266492	100 st.

Tape / Slang



Isolatie tape

PVC / -10 °C tot +105 °C / met lijm

Artikelnummer	Lengte:	Breedte:	Dikte	Kleur:	VPE:
50272116	10 mtr	15	0,1	Blauw	20 st.
50272115	10 mtr	15	0,1	Rood	20 st.
50272114	10 mtr	15	0,1	Groen	20 st.
50272113	10 mtr	15	0,1	Grijs	20 st.
50272112	10 mtr	15	0,1	Geel	20 st.
50272111	10 mtr	15	0,1	Wit	20 st.
50272110	10 mtr	15	0,1	Zwart	20 st.

Isolatie tape

PE (Polyethylene) / -20 °C tot 80 °C / met lijm-synthetisch rubber

Artikelnummer:	Lengte:	Breedte:	Dikte	Kleur:	VPE:
50272155	50 mtr	50mm	0,2mm	Blauw	1 st.



Gegolfde pijp Polyamid 6

-40 °C tot + 150 °C

UV-bestendig, Solvent-bestendig, Oliebestendig

Artikelnummer	Buig Radius	Wanddikte:	Buiten Diam.:	Binnen Diam.:	VPE:
51271150	11mm	0,15mm	10,0mm	6,6mm	50m.
51271151	13mm	0,20mm	11,5mm	8,4mm	50m.
51271152	15mm	0,30mm	12,8mm	9,8mm	50m.
51271153	20mm	0,30mm	15,7mm	12,3mm	50m.
51271154	20mm	0,30mm	16,0mm	12,7mm	50m.
51271155	25mm	0,30mm	18,5mm	14,2mm	50m.
51271156	28mm	0,30mm	18,9mm	14,9mm	50m.
51271157	30mm	0,30mm	21,1mm	16,6mm	50m.
51271158	35mm	0,30mm	25,5mm	21,2mm	50m.
51271159	40mm	0,30mm	28,4mm	23,1mm	50m.
51271160	45mm	0,30mm	31,2mm	25,7mm	25m.
51271161	50mm	0,30mm	34,5mm	28,9mm	25m.
51271162	65mm	0,40mm	42,2mm	34,0mm	25m.
51271163	90mm	0,40mm	53,8mm	45,6mm	25m.



Krimpkaus

Krimpkaus 2:1

-55 °C tot + 135 °C

Artikelnummer	Wanddikte:	Diameter 1/2:	Kleur	VPE:
51273318	0,5 mm	3,2 mm / 1,6 mm	zwart	10m.
51273319	0,5 mm	4,8 mm / 2,4 mm	zwart	10m.
51273316	0,5 mm	2,4 mm / 1,2 mm	zwart	12.5m.
51273322	0,6 mm	12,7 mm / 6,4 mm	zwart	5m.
51273320	0,6 mm	6,4 mm / 3,2 mm	zwart	5m.
51273321	0,6 mm	9,5 mm / 4,7 mm	zwart	5m.



Krimpkaus 3:1

-55 °C tot + 125 °C

Artikelnummer	Wanddikte:	Diameter 1/2:	Kleur	VPE:
51273341	1,2 mm	24 mm / 8 mm	zwart	3m.
51273340	0,85 mm	12 mm / 4 mm	zwart	5m.
51273339	0,7 mm	6 mm / 2 mm	zwart	5m.
51273337	0,5 mm	1,5 mm / 0,5 mm	zwart	10m.
51273338	0,6 mm	3 mm / 1 mm	zwart	10m.



Krimpkaus 3:1 – met lijm

-55 °C tot + 125 °C

Artikelnummer	Wanddikte:	Diameter 1/2:	Kleur	VPE:
51273207	1 mm	6 mm / 2 mm	zwart	5m.
51273206	1 mm	3 mm / 1 mm	zwart	10m.
51273208	1,4 mm	9 mm / 3 mm	zwart	5m.
51273209	1,8 mm	12 mm / 4 mm	zwart	5m.
51273210	2,25 mm	18 mm / 6 mm	zwart	4m.
51273221	2,5 mm	24 mm / 8 mm	zwart	2,5m.



Assortiment

Krimpkaus 3:1 - Incl. Standaard en schaar.

Artikelnummer:	Aantal:
54273031	1 st.

Inhoud	Artikelnummer:	Diameter 1/2:	Kleur:	Aantal
Krimpkaus	51273340	12 mm / 4 mm	Zwart	2 st.
	51273341	24 mm / 4 mm	Zwart	1 st.
	51273338	3 mm / 1 mm	Zwart	1 st.
	51273339	6 mm / 2 mm	Zwart	1 st.
Schaar	95942329			1 st.



Heteluchtföhn

Artikelnummer:	Aantal:
95920000	1 st.



Electrodraad

Elektriciteitsdraad
PVC / -40 °C tot +80 °C



Artikelnummer	Draad mm ²	Kleur:	VPE:
51275105000	1 x 0,50mm	Zwart	50 m.
51275105001	1 x 0,50mm	Wit	50 m.
51275105002	1 x 0,50mm	Geel	50 m.
51275105004	1 x 0,50mm	Groen	50 m.
51275105005	1 x 0,50mm	Rood	50 m.
51275105006	1 x 0,50mm	Blauw	50 m.
51275105007	1 x 0,50mm	Bruin	50 m.
51275106000	1 x 0,75mm	Zwart	50 m.
51275106001	1 x 0,75mm	Wit	50 m.
51275106002	1 x 0,75mm	Geel	50 m.
51275106003	1 x 0,75mm	Grijs	50 m.
51275106004	1 x 0,75mm	Groen	50 m.
51275106005	1 x 0,75mm	Rood	50 m.
51275106006	1 x 0,75mm	Blauw	50 m.
51275106007	1 x 0,75mm	Bruin	50 m.
51275107000	1 x 1,00mm	Zwart	50 m.
51275107001	1 x 1,00mm	Wit	50 m.
51275107002	1 x 1,00mm	Geel	50 m.
51275107004	1 x 1,00mm	Groen	50 m.
51275107005	1 x 1,00mm	Rood	50 m.
51275107006	1 x 1,00mm	Blauw	50 m.
51275107007	1 x 1,00mm	Bruin	50 m.
51275108000	1 x 1,50mm	Zwart	50 m.
51275108001	1 x 1,50mm	Wit	50 m.
51275108002	1 x 1,50mm	Geel	50 m.
51275108003	1 x 1,50mm	Grijs	50 m.
51275108004	1 x 1,50mm	Groen	50 m.
51275108005	1 x 1,50mm	Rood	50 m.
51275108006	1 x 1,50mm	Blauw	50 m.
51275108007	1 x 1,50mm	Bruin	50 m.
51275108008	1 x 1,50mm	Lila	50 m.
51275128001	1 x 1,50mm	Wit/Zwart	50 m.
51275128004	1 x 1,50mm	Zwart/Groen	50 m.
51275128005	1 x 1,50mm	Rood/Zwart	50 m.
51275128021	1 x 1,50mm	Wit/Geel	50 m.
51275128030	1 x 1,50mm	Zwart/Grijs	50 m.
51275128035	1 x 1,50mm	Grijs/Rood	50 m.
51275128041	1 x 1,50mm	Wit/Groen	50 m.
51275128052	1 x 1,50mm	Rood/Geel	50 m.
51275128061	1 x 1,50mm	Wit/Blauw	50 m.
51275128071	1 x 1,50mm	Wit/Bruin	50 m.

Artikelnummer	Draad mm ²	Kleur:	VPE:
51275109000	1 x 2,50mm	Zwart	50 m.
51275109001	1 x 2,50mm	Wit	50 m.
51275109002	1 x 2,50mm	Geel	50 m.
51275109004	1 x 2,50mm	Groen	50 m.
51275109005	1 x 2,50mm	Rood	50 m.
51275109006	1 x 2,50mm	Blauw	50 m.
51275109007	1 x 2,50mm	Bruin	50 m.
51275110000	1 x 4,00mm	Zwart	50 m.
51275110005	1 x 4,00mm	Rood	50 m.
51275110007	1 x 4,00mm	Bruin	50 m.
51275111000	1 x 6,00mm	Zwart	50 m.
51275111005	1 x 6,00mm	Rood	50 m.
51275111007	1 x 6,00mm	Bruin	50 m.
51275112000	1 x 10,00mm	Zwart	50 m.
51275112005	1 x 10,00mm	Rood	50 m.
51275113000	1 x 16,00mm	Zwart	25 m.
51275113005	1 x 16,00mm	Rood	25 m.
51275114000	1 x 25,00mm	Zwart	25 m.
51275114005	1 x 25,00mm	Rood	25 m.
51275115000	1 x 35,00mm	Zwart	25 m.
51275115005	1 x 35,00mm	Rood	25 m.
51275116000	1 x 50,00mm	Zwart	25 m.
51275116005	1 x 50,00mm	Rood	25 m.
51275117000	1 x 70,00mm	Zwart	25 m.
51275117005	1 x 70,00mm	Rood	25 m.

**Naast deze standaard
elektriciteitsdraden heeft
Herth&Buss ook meer aderige en
andere soorten draden in hun
assortiment.**

**Deze zijn terug te vinden in de
“Herth&Buss Elparts Installation”
Documentatie.**

Electrodraad

Electrokabel 7-aderig

Artikelnummer:	aantal	Kleuren	VPE:
51275578000	7 x 1,5 mmq	ZW/BR/WI/RO/BL/GR/GE	50mtr.

Electrokabel 13-aderig

Artikelnummer:	aantal	Kleuren	VPE:
51275682000	9 x 1.5 mmq	ZW(4x)/GE/BL/GR/BR/RO	50mtr.
	4 x 2,5 mmq	ZW(3x)/WI	

Speakerkabel 2-aderig

Artikelnummer:	aantal	Kleuren	VPE:
51275025005	2 x 0,75 mmq	Zwart/Rood	50mtr.



Ruitensproeierslang



NIEUW

Ruitensproeierslang PVC

Artikelnummer:	Binnen Dia	Buiten Dia	VPE:
51280704	4.0mm	6.0mm	15 m.
51280705	5.0mm	7.4mm	15 m.
51280706	6.0mm	8.4mm	15 m.
51280708	8.0mm	11.0mm	15 m.
51280710	10.0mm	14.0mm	15 m.

Transparante PVC-slangen voor ruitenwasinstallatie, ontluchting en ontluchtingsoverloop. Niet geschikt voor het transporteren van brandstof.
3bar / van -20 °C, tot +70 °C

Slangklemmen

Brandstofslangklem Staal DIN 3017-2



Artikelnummer:	Breedte	Diam.	VPE:
50268307	7mm	7mm	100 st.
50268308	7mm	8mm	100 st.
50268309	9mm	9mm	100 st.
50268310	9mm	10mm	100 st.
50268311	9mm	11mm	100 st.
50268312	9mm	12mm	100 st.
50268313	9mm	13mm	100 st.
50268314	9mm	14mm	100 st.
50268315	9mm	15mm	100 st.
50268316	9mm	16mm	100 st.
50268317	9mm	17mm	100 st.
50268318	9mm	18mm	100 st.
50268320	9mm	20mm	100 st.

Slangklem Wira + rubber

Artikelnummer:	Diam.:
48700062	6 mm
48700082	8 mm
48700102	10 mm
48700122	12 mm
48700152	15 mm
48700182	18 mm



Assortiment Slangklemmen

Incl. Rek

Artikelnummer:	Aantal:
54268011	100 st.

Inhoud	Artikelnummer:	Diam.:	Aantal
Slangklemmen	50268202	12 – 22	10 st.
	50268204	16 – 27	10 st.
	50268205	20 – 32	10 st.
	50268207	25 – 40	10 st.
	50268209	32 – 50	10 st.
	50268210	40 – 60	10 st.
	50268211	50 – 70	10 st.
	50268212	60 – 80	10 st.
	50268200	8 – 12	10 st.
	50268216	8 – 16	10 st.

Slangklemmen Chroomstaal DIN 3017-1



Artikelnummer:	Breedte	Diam.	VPE:
50268201-10	7,5mm	10 – 16	10 st.
50268200-10	7,5mm	8 – 12	10 st.
50268202-10	9mm	12 – 22	10 st.
50268204-10	9mm	16 – 27	10 st.
50268205-10	9mm	20 – 32	10 st.
50268207-10	9mm	25 – 40	10 st.
50268209-10	9mm	32 – 50	10 st.
50268210-10	9mm	40 – 60	10 st.
50268211-10	9mm	50 – 70	10 st.
50268212	9mm	60 – 80	25 st.
50268213	9mm	70 – 90	25 st.
50268216-10	9mm	8 – 16	10 st.
50268214	9mm	80 – 100	25 st.
50268215	9mm	90 – 110	25 st.
50268217	12mm	16 – 27	25 st.
50268218	12mm	20 – 32	25 st.
50268233	12mm	25 – 40	10 st.
50268234	12mm	32 – 50	10 st.
50268223	12mm	40 – 60	25 st.
50268224	12mm	50 – 70	25 st.
50268226	12mm	70 – 90	25 st.
50268228	12mm	90 – 110	20 st.

* artikelen met "-10" zijn ook verkrijgbaar in grootverpakking van 50 of 100 stuks



Slangen



Brandstofslangen

Artikelnummer:	Diam.	VPE:
51280132	3.2mm	15 m.
51280140	4.0mm	15 m.
51280145	4.5mm	15 m.
51280150	5.0mm	15 m.
51280155	5.5mm	15 m.
51280160	6.0mm	15 m.
51280170	7.0mm	15 m.
51280175	7.5mm	10 m.
51280180	8.0mm	10 m.
51280195	9.5mm	10 m.
51280210	10.0mm	10 m.
51280212	12.0mm	5 m.

Geschikt voor o.a. E10 en Bio-diesel

Brandstofslangen van rubber met **versterkende voering** voor het transporteren van benzine (E5, E10, E15, E85), diesel en bio-diesel (B10, B20). Bestand tegen olie, zuur, hitte, ozon en weersinvloeden.



Brandstofslangen

Artikelnummer:	Diam.	VPE:
51280232	3.2mm	15 m.
51280235	3.5mm	15 m.
51280245	4.5mm	15 m.
51280255	5.5mm	15 m.
51280275	7.5mm	15 m.
51280295	9.5mm	10 m.
51280311	11.0mm	10 m.

Geschikt voor o.a. E10 en Bio-diesel

Brandstofslangen met **ge vulkaniseerd draadvlechtwerk** voor het transporteren van benzine (E5, E10, E15, E85), diesel en bio-diesel (B10, B20).

Lampen



Gloeilamp
H7 12V 55W PX26d

Artikelnummer: 89901202
VPE: 1 st.



Gloeilamp
H1 12V 55W P14,5s

Artikelnummer: 89901092
VPE: 1 st.



Gloeilamp
H4 12V 60/55W P43t

Artikelnummer: 89901100
VPE: 1 st.



Gloeilamp
P21W 12V 21W BA15s

Artikelnummer: 89901102
VPE: 10 st.



Gloeilamp
P21/5W 12V 21W/5 BAY15d

Artikelnummer: 89901103
VPE: 10 st.



Gloeilamp
T4W 12V 4W BA9s

Artikelnummer: 89901132
VPE: 10 st.



Gloeilamp
R5W 12V 5W BA15s

Artikelnummer: 89901140
VPE: 10 st.



Gloeilamp
R10W 12V 10W BA15s

Artikelnummer: 89901141
VPE: 10 st.



Gloeilamp Buislamp
C5W 12V 5W SV8,5-8

Artikelnummer: 89901150
VPE: 10 st.



Gloeilamp
T5 12V 1,2W W2x4,6d

Artikelnummer: 89901170
VPE: 10 st.



Gloeilamp
W5W 12V 5W W2,1x9,5d

Artikelnummer: 89901175
VPE: 10 st.



Gloeilamp
PY21W 12V 21W BAU15s

Artikelnummer: 89901190
VPE: 10 st.



Gloeilamp
P21/4W 12V 21/4W BAZ15d

Artikelnummer: 89901195
VPE: 10 st.



Gloeilamp
W21/5W 12V 21/5W W3x16q

Artikelnummer: 89901197
VPE: 10 st.



Gloeilamp
P21/5W 12V 21/5W BA15d

Artikelnummer: 89901075
VPE: 10 st.



Gloeilamp
H6W 12V 6W BAX9s

Artikelnummer: 89901245
VPE: 10 st.



Gloeilamp
W16W 12V 16W W2,1x9,5d

Artikelnummer: 89901274
VPE: 10 st.



Gloeilamp
D1S 12V 35W Pk32d-2

Artikelnummer: 89901320
VPE: 1 st.



Zie "Herth&Buss Elparts Bulbs" documentatie voor alle gloeilampen
Te bestellen in onze webshop. Art.nr.: KATALOG09EN

Lamphouder

Lamphouder
W5W



Artikelnummer:	Opmerking	VPE:
85785021	kunststof / 2 polen	1st.

Lamphouder
BA15s



Artikelnummer:	Opmerking	VPE:
85785102	Metaal / 1 pool	5 st.

Lampstekker
H7 – met kabel



Artikelnummer:	Opmerking	VPE:
50390437	Kunststof / 2 polen	1st.

Lamphouder met voet
BA15s



Artikelnummer:	Opmerking	VPE:
85785145	Metaal / 1 pool	5 st.

Lamphouder
BA15d



Artikelnummer:	Opmerking	VPE:
85785103	Metaal / 2 polen	10st.

Lamphouder met voet
BA15d



Artikelnummer:	Opmerking	VPE:
85785146	Metaal / 2 polen	5 st.

Lamphouder
H4



Artikelnummer:	Opmerking	VPE:
50290023	R2 (Bilux) / 3 polen	10st.

Lamphouder
H7 – met kabel



Artikelnummer:	Opmerking	VPE:
50390299	Kunststof / 2 polen	1 st.

Batterijen

Knoopcel

Artikelnummer:	Type:	VPE:
BAT-CR1616	CR1616	1 st.
BAT-CR1620	CR1620	1 st.
BAT-CR1632	CR1632	1 st.
BAT-CR2016	CR2016	1 st.
BAT-CR2025	CR2025	1 st.
BAT-CR2032	CR2032 </td <td>1 st.</td>	1 st.
BAT-CR2430	CR2430	1 st.



PHILIPS

NIUW

Werklampen

Werklamp 123mm - 9 LED
12-36V / 22 W / 2160 lm

Artikelnummer:	Maat:	VPE:
80690310	123x142x58mm	1 st.



Werklamp 105mm - 6 LED
12-36V / 18 W / 1440 lm

Artikelnummer:	Maat:	VPE:
80690312	105x134x52mm	1 st.



Werklamp 106mm - 4 LED
12-36V / 50 W / 3200 lm

Artikelnummer:	Maat:	VPE:
80690313	106x127x77mm	1 st.



LAZER LED lampen – Wil je de beste, dan kies je LAZER.
Ongeëvenaard in kwaliteit, performance en garantie

LAZER Werklamp 110mm - 4 LED
9-32V / 80 W / 8820 lm

Artikelnummer:	Maat:	VPE:
LZRO0U80-G2-WIDE	110x108x85mm	1 st.



Ford Transit 2018->Grill kit

LAZER Verstralers - LED

9-32V

Artikelnummer:	LED:	Watt:	lm:	VPE:
LZROL06-LNR-EL	6	42W	4050 lm	1 st.
LZROL12-LNR-EL	12	84W	8100 lm	1 st.
LZROL18-LNR-EL	18	126W	12150 lm	1 st.



**5 JAAR
GARANTIE**

LAZER
HIGH PERFORMANCE LIGHTING

Kogellagers

2RS - kogellagers - met 2 keerringen

Artikelnummer:	Gat:	Diam.:	Breedte:	VPE:
TIM626	6	19	6	1 st.
TIM607	7	19	6	1 st.
TIM608	8	22	7	1 st.
TIM628	8	24	8	1 st.
TIM629	9	26	8	1 st.
TIM6000	10	26	8	1 st.
TIM6200	10	30	9	1 st.
TIM6300	10	35	11	1 st.
TIM6001	12	28	8	1 st.
TIM6201	12	32	10	1 st.
TIM6301	12	37	12	1 st.
TIM6002	15	32	9	1 st.
TIM6202	15	35	11	1 st.
TIM6302	15	42	13	1 st.
TIM6003	17	35	10	1 st.
TIM6203	17	40	12	1 st.
TIM6303	17	47	14	1 st.
TIM6004	20	42	12	1 st.
TIM6204	20	47	14	1 st.
TIM6304	20	52	15	1 st.
TIM6005	25	47	12	1 st.
TIM6205	25	52	15	1 st.
TIM6305	25	62	17	1 st.
TIM6006	30	55	13	1 st.
TIM6206	30	62	16	1 st.
TIM6306	30	72	19	1 st.
TIM6007	35	62	14	1 st.
TIM6207	35	72	17	1 st.
TIM6307	35	80	21	1 st.
TIM6008	40	68	15	1 st.
TIM6208	40	80	18	1 st.
TIM6308	40	90	23	1 st.
TIM6009	45	75	16	1 st.
TIM6209	45	85	19	1 st.
TIM6309	45	100	25	1 st.



TIMKEN
Where You Turn

Het complete assortiment **TIMKEN** lagers is beschikbaar via EPS Automotive.

Neem contact op met onze afdeling verkoop via:
T +31 (0)416-337334 of order@epsautomotive.nl

Remschijf montage bout

	<p>TPM0001 Lengte: 15mm M6x1 Staal Binnen zeskant Aantal per VPE: 2</p>		<p>TPM0006 Lengte: 16.1mm M8x1.25 Staal Binnen zeskant Aantal per VPE: 2</p>
	<p>TPM0002 Lengte: 12.5mm M8x1 Staal Binnen Torx Aantal per VPE: 2</p>		<p>TPM0007 Lengte: 19.4mm M10x1.25 Staal Binnen zeskant Aantal per VPE: 2</p>
	<p>TPM0003 Lengte: 15.7mm M8x1.25 Staal Binnen zeskant Aantal per VPE: 2</p>		<p>TPM0008 Lengte: 16.1mm M6x1 Staal Binnen Torx Aantal per VPE: 2</p>
	<p>TPM0004 Lengte: 21.3mm M12x1.5 Staal Binnen Torx Aantal per VPE: 2</p>		<p>TPM0009 Lengte: 15.6mm M8x1.25 Staal Binnen zeskant Aantal per VPE: 2</p>
	<p>TPM0005 Lengte: 21.3mm M12x1.5 Staal Binnen Torx Aantal per VPE: 2</p>		<p>TPM0010 Lengte: 18.9mm M10x1.5 Staal Binnen Torx Aantal per VPE: 2</p>

ENGINE (Motor)



Eurol ATF Treat
Olieadditief om automatische transmissies soepeler te laten schakelen
 Artikelnummer: VPE:
 E802314 500ml 1 st.

Eurol Engine Flush
Olieadditief voor het reinigen van de motor.
 Artikelnummer: VPE:
 E802310 500ml 1 st.



Eurol Engine Oil Treat
Olieadditief voor wrijvingsvermindering op basis van Tungsten technologie
 Artikelnummer: VPE:
 E802315 250ml 1 st.

Eurol Powersteering Flush
Olieadditief voor stuurbekrachtigings-systemen
 Artikelnummer: VPE:
 E802319 500ml 1 st.



Eurol Engine Stop Leak
Olie additief om oliekkages te elimineren
 Artikelnummer: VPE:
 E802312 250ml 1 st.

Eurol Visco Oil Plus
Olie additief voor het reduceren van het olieverbruik
 Artikelnummer: VPE:
 E802313 250ml 1 st.



Eurol Transmission Flush
Olie additief voor de reiniging van automatische transmissies
 Artikelnummer: VPE:
 E802311 500ml 1 st.

Eurol Hydraulic Tappet Valve
Olieadditief gericht op het verminderen van klepstotergeluid
 Artikelnummer: VPE:
 E802321 250ml 1 st.



Eurol Transmission Stop Leak
Olie additief om oliekkages van de transmissie te elimineren
 Artikelnummer: VPE:
 E802320 250ml 1 st.

Eurol TBN Booster
Olieadditief om de levensduur van de motorolie te verlengen
 Artikelnummer: VPE:
 E802316 250ml 1 st.





DIESEL



Eurol Diesel Flow Improver
Brandstofadditief voor de verlaging van het vloeipunt van diesel

Artikelnummer:	VPE:
E802484	250ml 1 st.



Eurol Diesel Fuel Treat
Brandstofadditief voor het conserveren van dieselbrandstof

Artikelnummer:	VPE:
E802494	250ml 1 st.

Eurol Diesel Performance Plus
Brandstofadditief om de prestaties van diesel te verbeteren

Artikelnummer:	VPE:
E802490	250ml 1 st.



Eurol Diesel System Cleaner
Brandstofadditief voor het onderhoud van het gehele brandstofsysteem

Artikelnummer:	VPE:
E802493	250ml 1 st.

Eurol Diesel Clean Direct
Brandstofadditief om het diesel brandstofsysteem te reinigen

Artikelnummer:	VPE:
E802495	500ml 1 st.



Eurol Diesel Injection Cleaner
Diesel additief voor reiniging en bescherming van diesel injectoren

Artikelnummer:	VPE:
E802492	250ml 1 st.

RADIATOR



Eurol Radiator Sealer
Radiator additief voor het dichten van lekkages

Artikelnummer:	VPE:
E802317	250ml 1 st.



PETROL (Benzine)



Eurol Petrol System Cleaner
Additief voor het onderhouden van het gehele brandstofsysteem

Artikelnummer:	VPE:
E802512 250ml	1 st.

Eurol Petrol Lead Replacement
Loodvervangend additief voor bescherming tegen klepinslag bij oldtimers

Artikelnummer:	VPE:
E802514 250ml	1 st.



Eurol Petrol Octane Improver
Brandstofadditief ter verhoging van octaangetal van benzine

Artikelnummer:	VPE:
E802516 250ml	1 st.

Eurol Petrol Injection Cleaner
Brandstofadditief voor het reinigen van benzine injectoren

Artikelnummer:	VPE:
E802511 250ml	1 st.



Eurol Petrol Fuel Treat
Brandstofadditief voor benzine conservering

Artikelnummer:	VPE:
E802515 250ml	1 st.

Eurol Petrol Power
Brandstofadditief ter verbetering van de algehele prestatie van benzine

Artikelnummer:	VPE:
E802510 250ml	1 st.



MOTORCYCLE (Motorfiets)



Eurol Motorcycle Octane Booster
Brandstofadditief ter verhoging van het octaangetal van benzine

Artikelnummer:	VPE:
E802812 100ml	1 st.

Eurol Motorcycle System Clean
Additief voor het onderhouden van het gehele brandstofsysteem

Artikelnummer:	VPE:
E802813 100ml	1 st.



Eurol Motorcycle Injection Cleaner
Brandstofadditief voor het reinigen van motorfietsinjectoren

Artikelnummer:	VPE:
E802811 100ml	1 st.

Eurol Motorcycle Fuel Treat
Brandstofadditief voor benzine conservering

Artikelnummer:	VPE:
E802810 100ml	1 st.



EUROL Overige

Hevelpomp Metaal
60L drums / 200L vaten

Artikelnummer: VPE:
E400318 1 st.



Hevelpomp Kunststof
60L drums / 200L vaten

Artikelnummer: VPE:
E400333 1 st.



Olievatmeter

Artikelnummer: VPE:
E400310 1 st.



Dopkraan
61mm / 20L Can

Artikelnummer: VPE:
E400168 1 st.



Vatkraan
60L drums / 200L vaten

Artikelnummer: VPE:
E400400 1 st.



Vatkraan
60L drums / 200L vaten

Artikelnummer: VPE:
E400420 1 st.



Hand Cleaner
Whitestar

Artikelnummer: VPE:
E601440 – 4,5L 1 st.



Hand Cleaner
Yellowstar

Artikelnummer: VPE:
E601430 – 4,5L 1 st.



Handpomp
4,5L Hand Cleaner

Artikelnummer: VPE:
E400771 1 st.



Wandrek
4,5L Hand Cleaner

Artikelnummer: VPE:
E400770 1 st.



Vloerabsorbent
10KG

Artikelnummer: VPE:
E401310 1 st.



Accuzuur

Artikelnummer: VPE:
E301300 – 1L 1 st.



AD-Blue
10 liter met schenktuit

Artikelnummer: VPE:
E301200 – 10L 1 st.



Bougiekabel

Bougiekabel op rol

Artikelnummer:	Kleur:	Maat:	VPE:
7mmsblack-BER	Zwart	7mm	15 m.
7mmsblue-BER	Blauw	7mm	15 m.
7mmsred-BER	Rood	7mm	15 m.



Carterplug assortiment

Artikelnummer:	Opmerking:
ASS-CP	18 ref / 19 st.



Carterplugging assortiment

Artikelnummer:	Opmerking:
574.577.001	24 ref / 760st.



TOPPER

Brandstof terugslagklep

Artikelnummer:	Kleur:	Maat:	VPE:
9042-MD	8/8mm		1 st.
9043-MD	10/10mm		1 st.
9044-MD	6/6mm		1 st.
9596-MD	12/12mm		1 st.



Brandstofpomp Universeel

Artikelnummer:	Omschrijving
77035-MD	Brandstofpomp universeel druk 0,15 bar



Werklampen Philips

X60POCKX1
LED WSL Pocket



X60FLAUX1
LED WSL Flood audio



X60FLX1
LED WSL Flood



X60FLMIX1
LED WSL Flood mini



X60SLIMX1
LED WSL Slim



X60PILLX1
LED WSL Pillar



X60UVPIX1
LED WSL UV Pillar



X60LINEX1
LED WSL Line



PHILIPS

ACCMUDOX1
Multi Dock station



ACCFIMDX1
Find my device ACCFIMD



Werklampen Philips

LPL67X1
PEN20S



LPL81X1
Penlight Premium
Color+



LPL35X1
CBL10 LED Lamp



PHILIPS

LPL73X1
CBH52 LED Lamp



LPL403MODX1
CBH52 LED Lamp



Werklampen Philips

RC220X1
LED WSL Ecopro30



RC420B1
LED WSL Ecopro40



RC620X1
LED WSL Ecopro61



RC320B1
LED WSL Ecopro20



RC520C1
LED WSL Ecopro50



PHILIPS





ACCU'S | KLEIN MATERIAAL | UNIVERSEEL
EPS AUTOMOTIVE | PASSIE | SPECIALIST | FOCUS

EPS Automotive

Spuiweg 23

5145 NE WAALWIJK

Nederland

T +31(0) 416-337334

order@epsautomotive.nl

KM2025-03